

# POLOHA OTVORŮ V PŘEDEM PŘEDPJATÝCH DUTINOVÝCH PANELECH HCE

vypracoval : Ing. Jan Vacík  
schválil : Ing. Vojtěch Horn

---

srpen 2008

# HCE150-0/5X

M 1:7,5

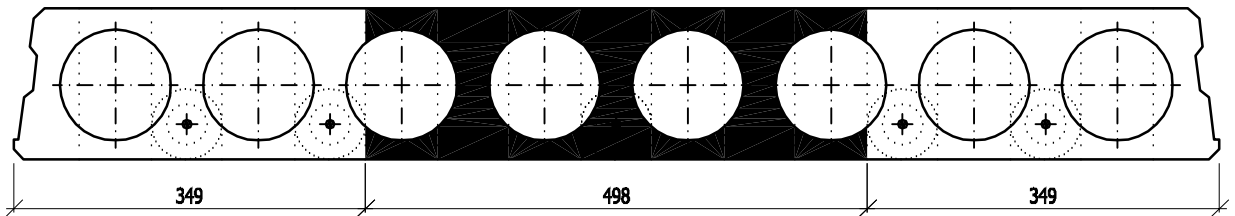
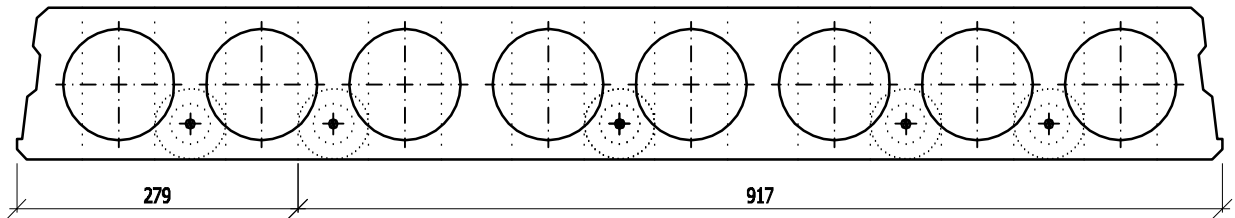
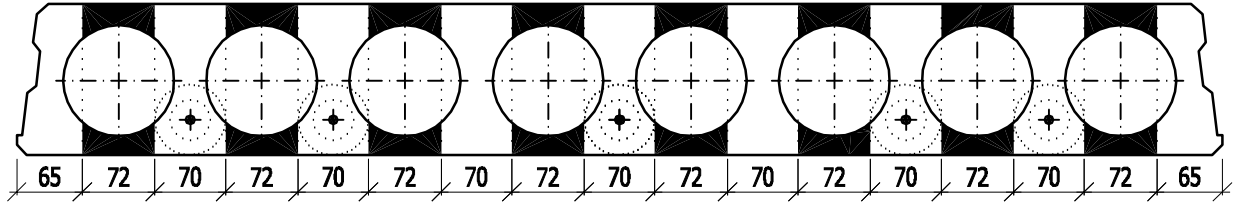

# HCE150-0/7X

M 1:7,5

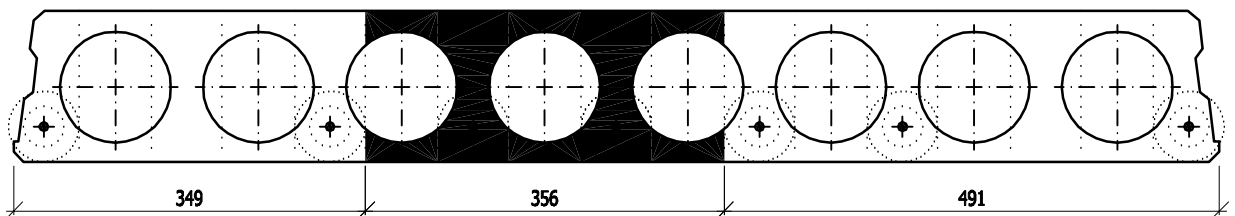
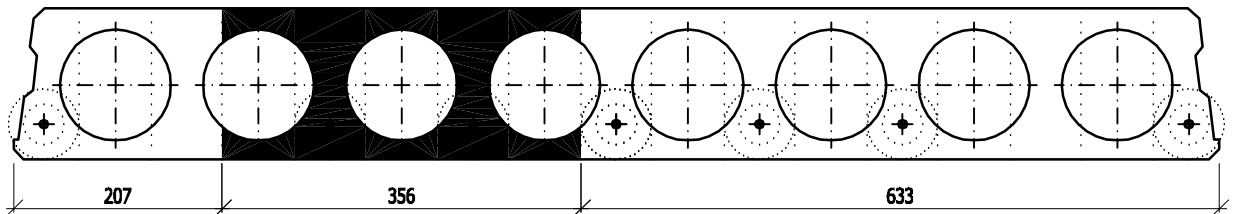
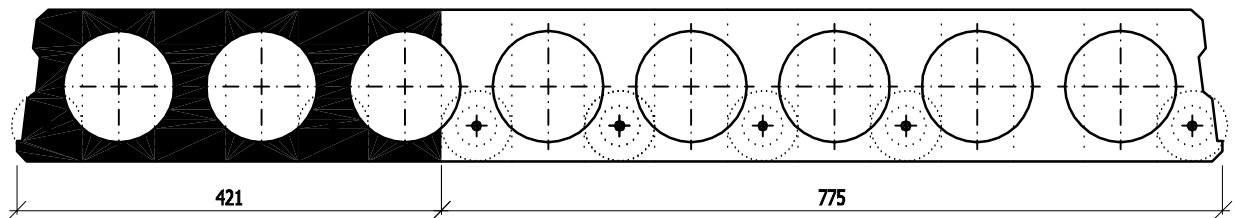
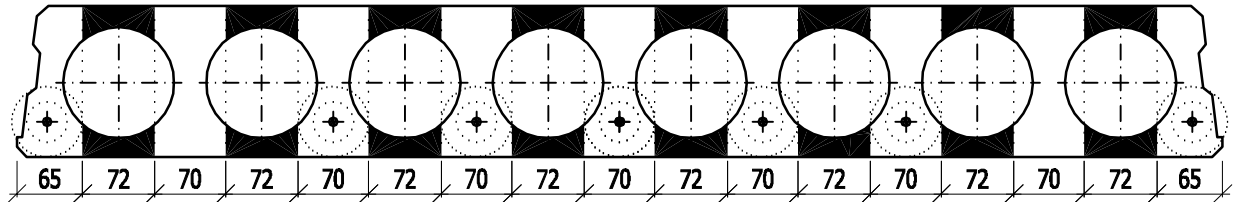

# HCE150-0/9X

M 1:7,5

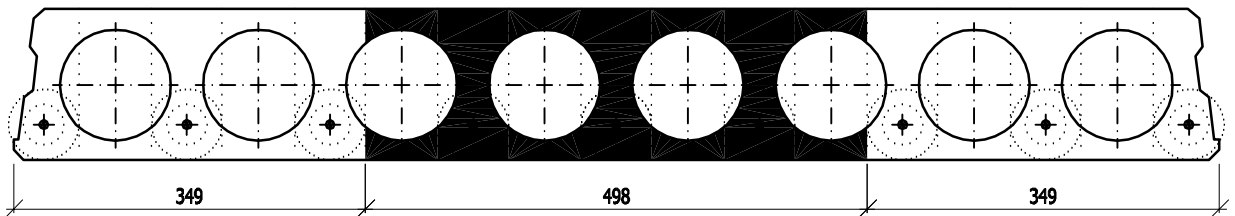
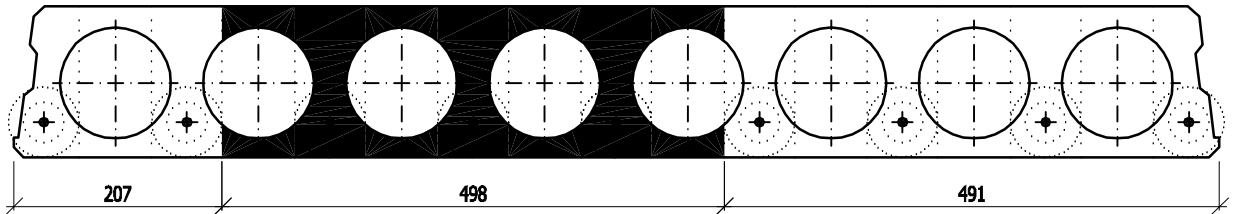
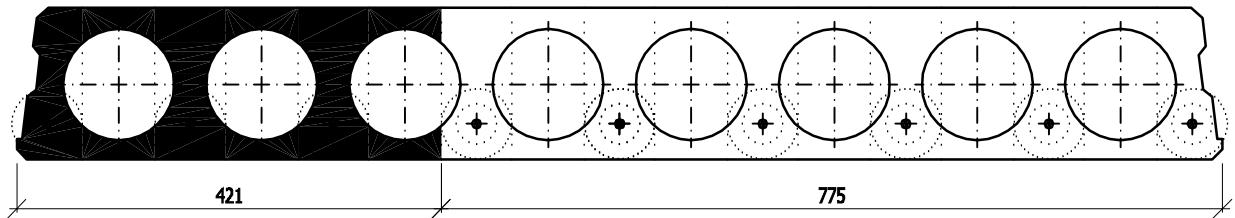
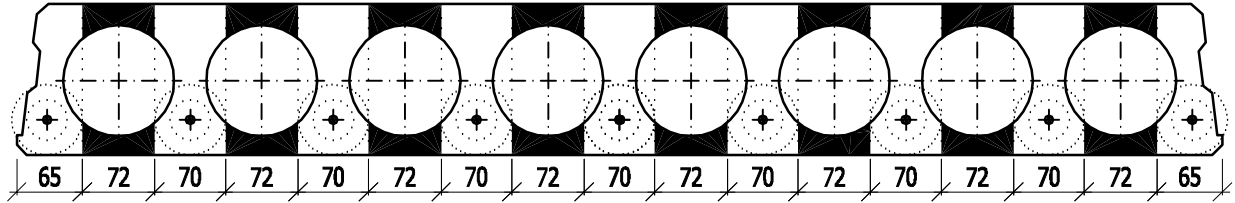

# HCE200-0/5X

M 1:7,5

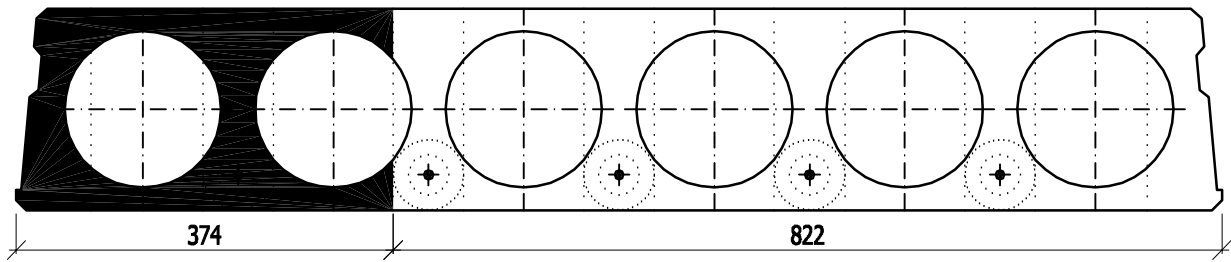
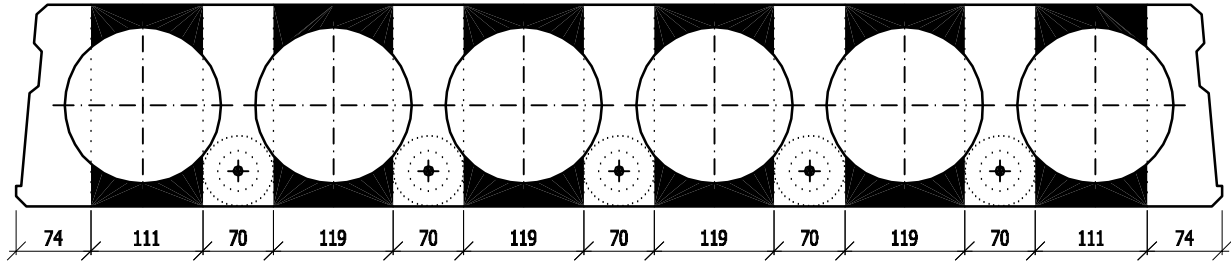

# HCE200 - 0/7X

M 1:7,5

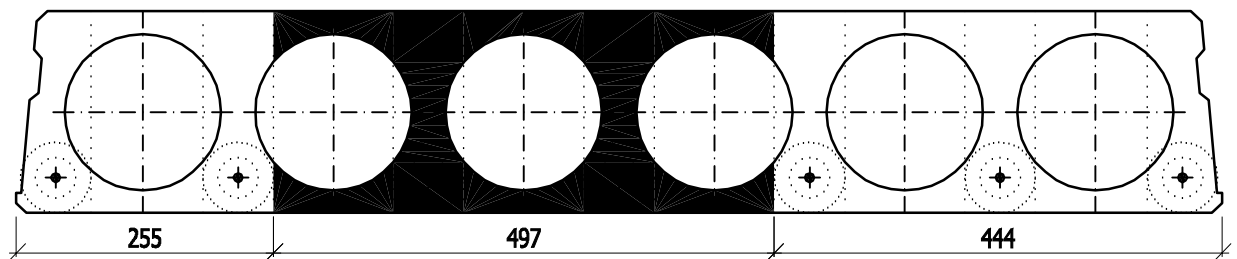
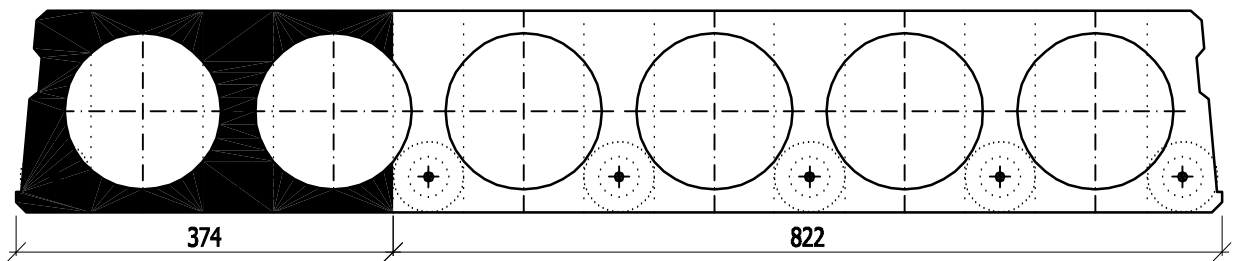
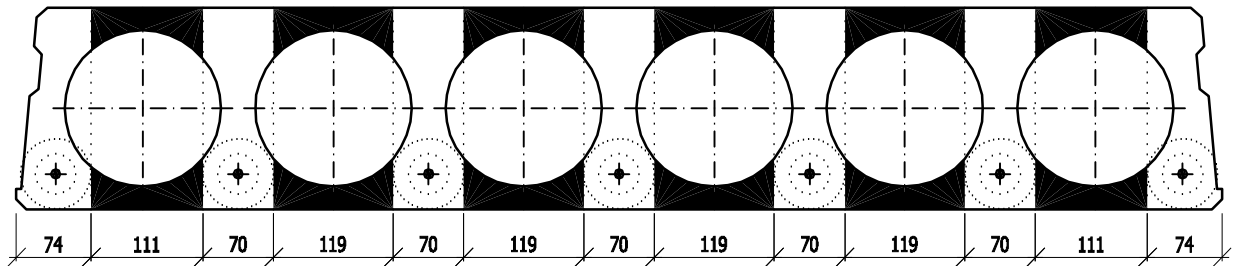

# HCE200 - 0/5

M 1:7,5

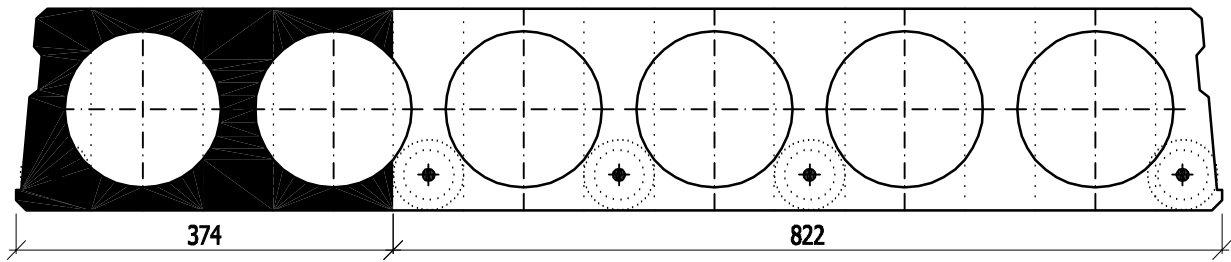
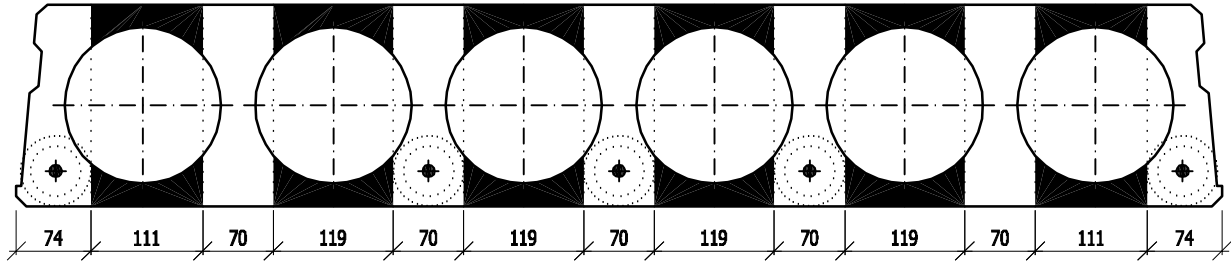

# HCE200 - 0/7

M 1:7,5

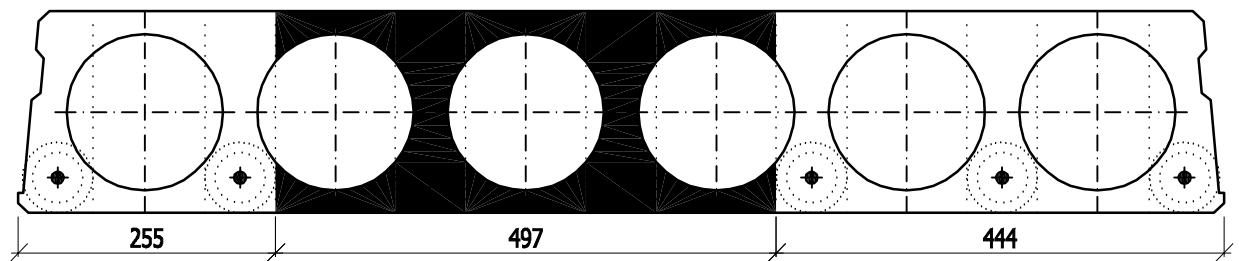
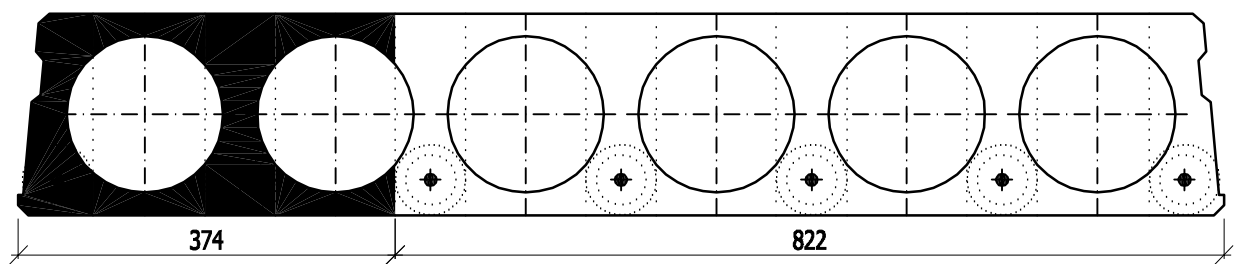
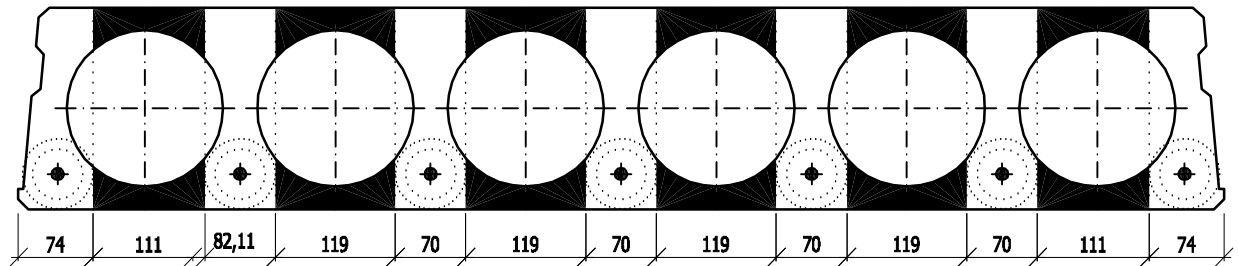

# HCE200 - 4X/5

M 1:7,5

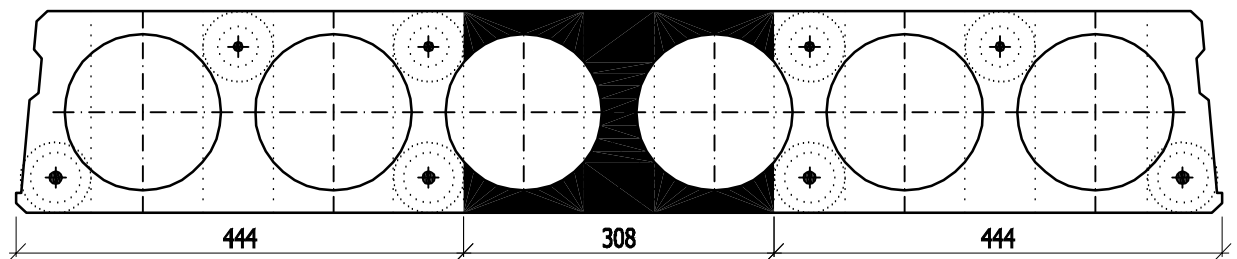
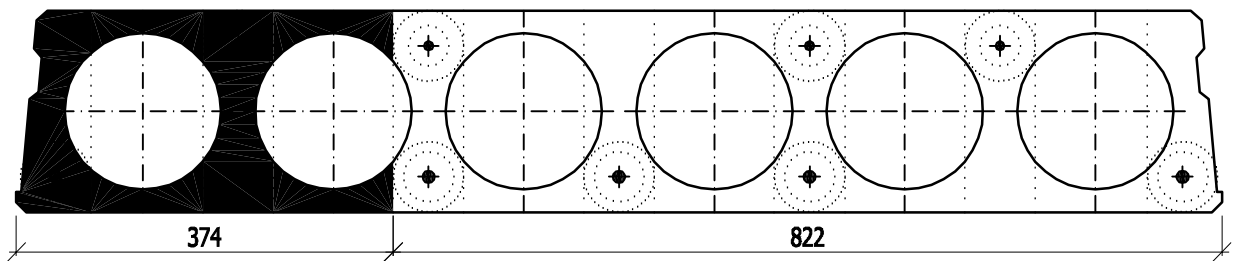
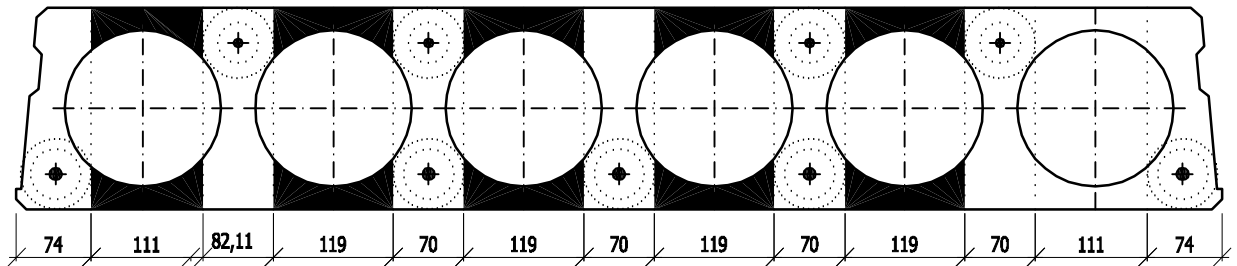

# HCE250 - 0/8X

M 1:7,5

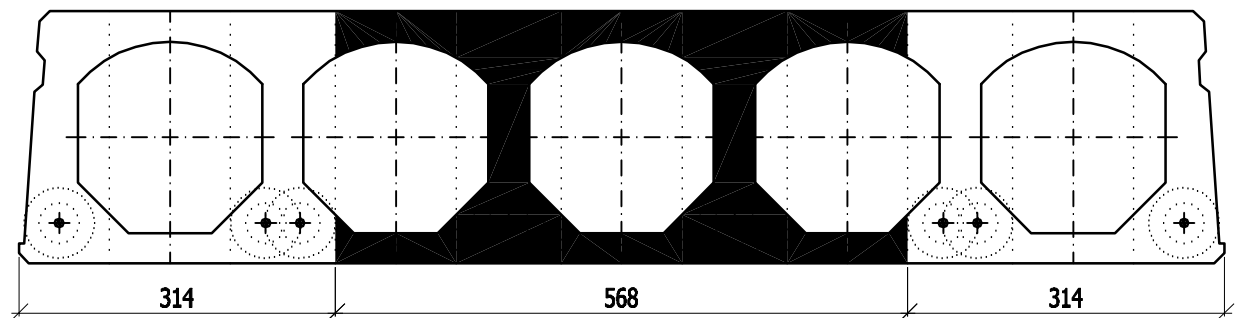
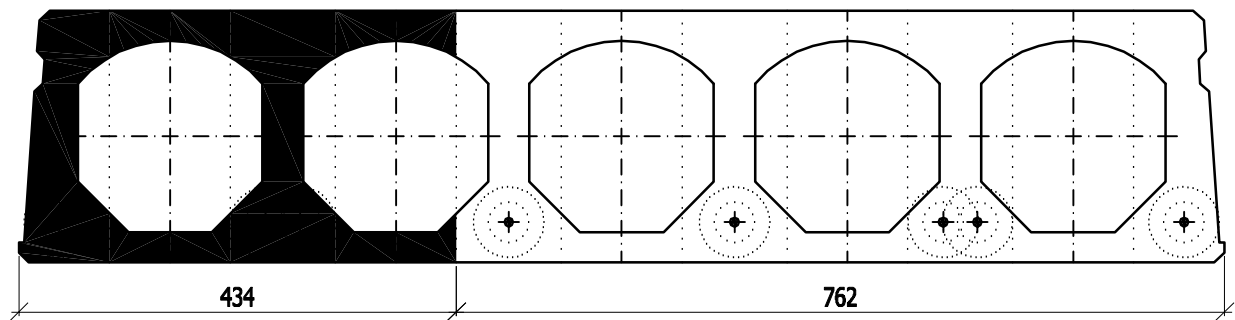
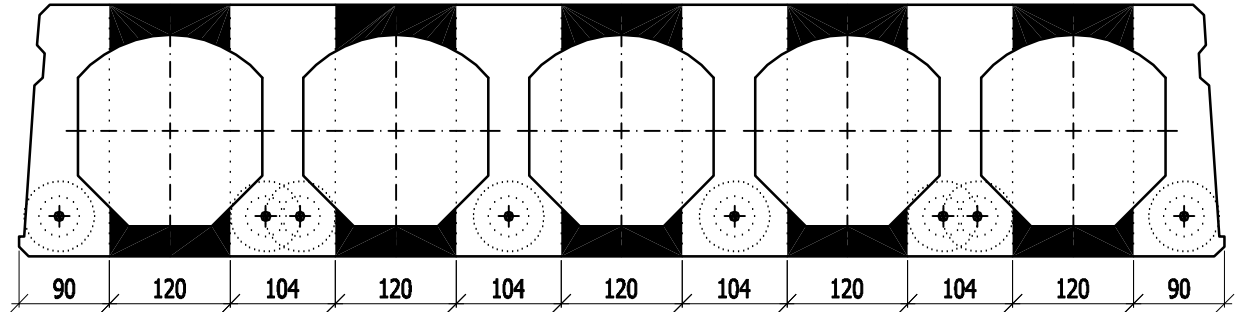

# HCE250 - 0/6

M 1:7,5

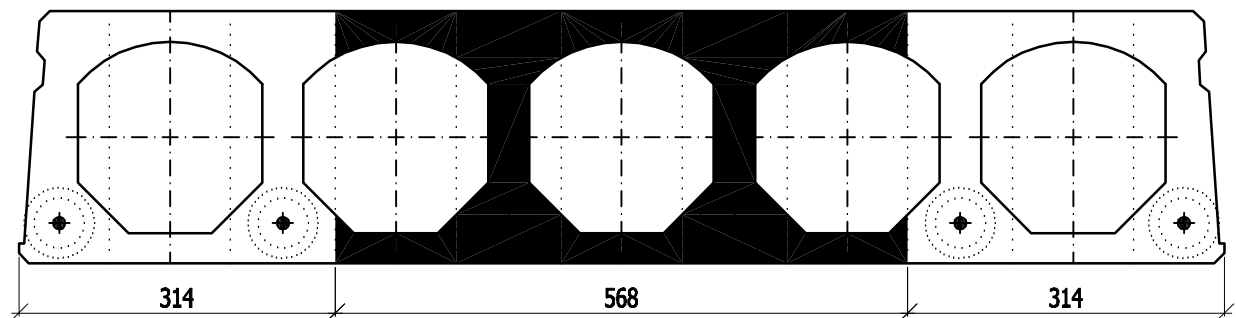
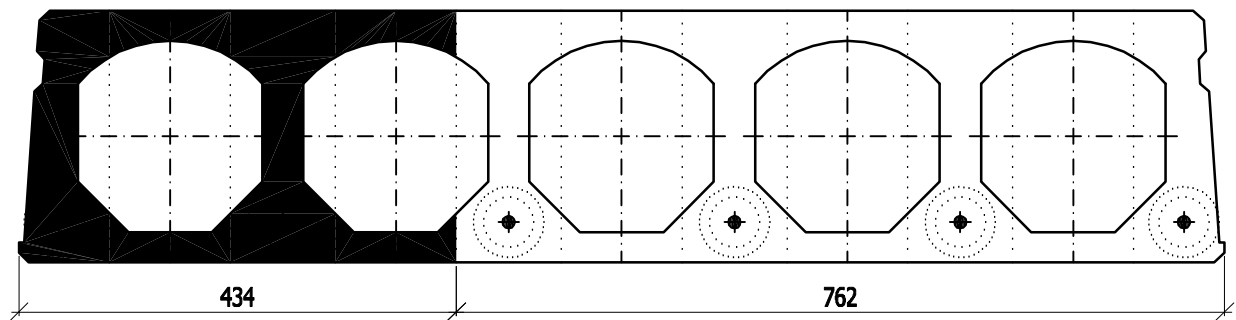
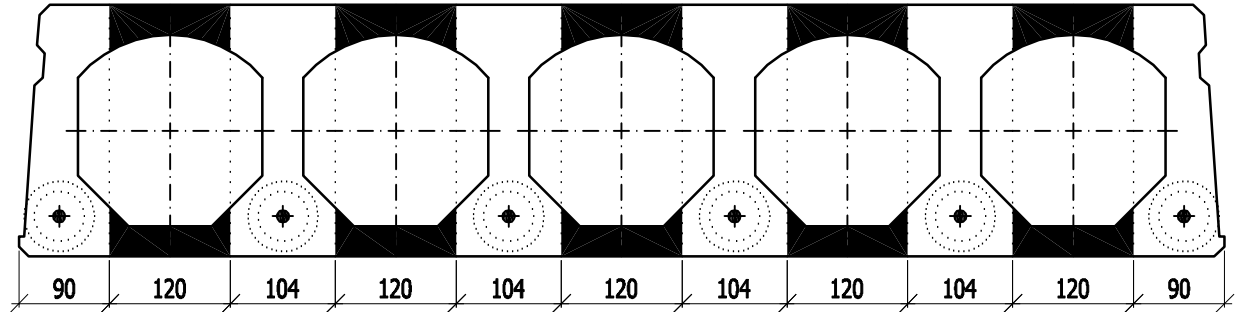

# HCE250 - 0/8

M 1:7,5

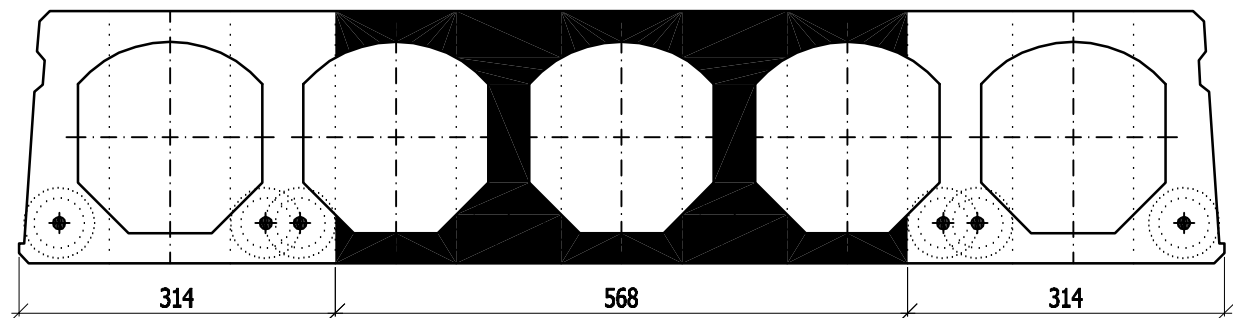
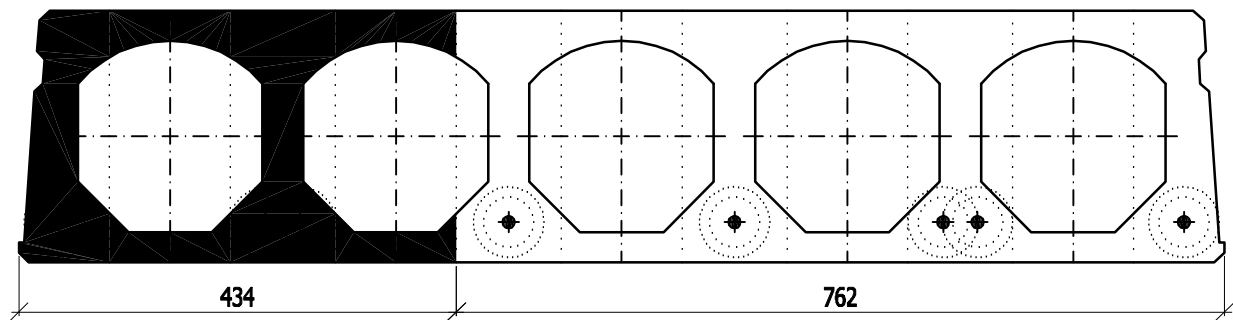
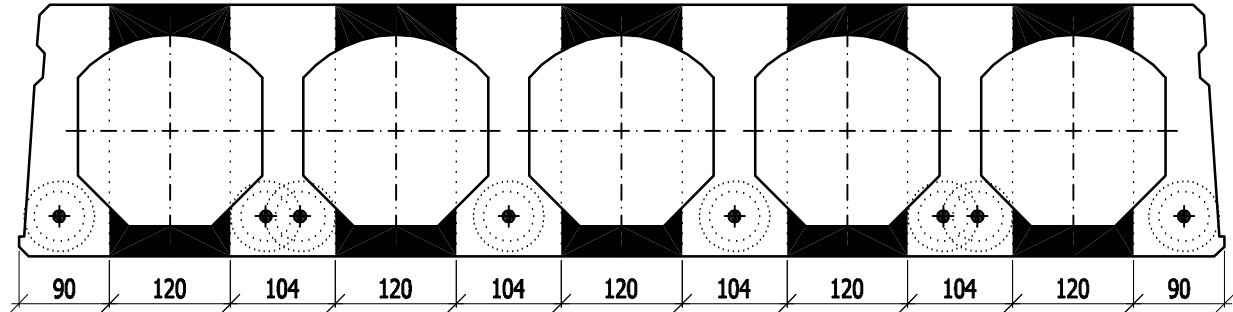

# HCE250 - 0/10

M 1:7,5

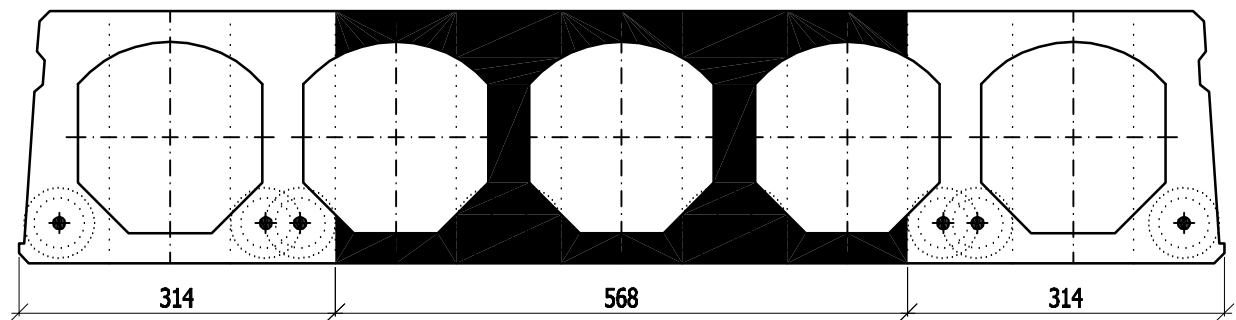
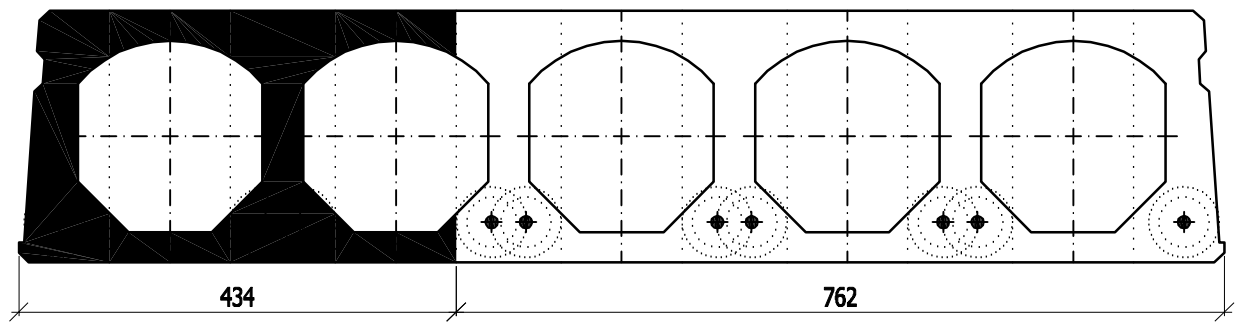
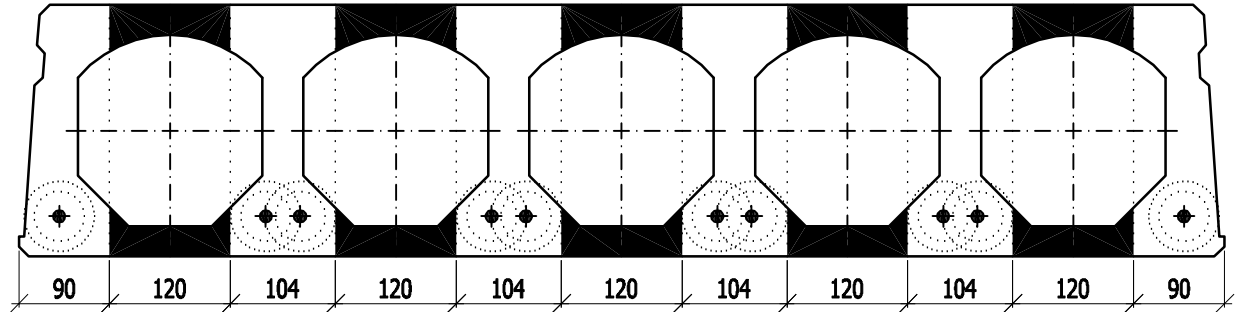

# HCE250 - 4X/6

M 1:7,5

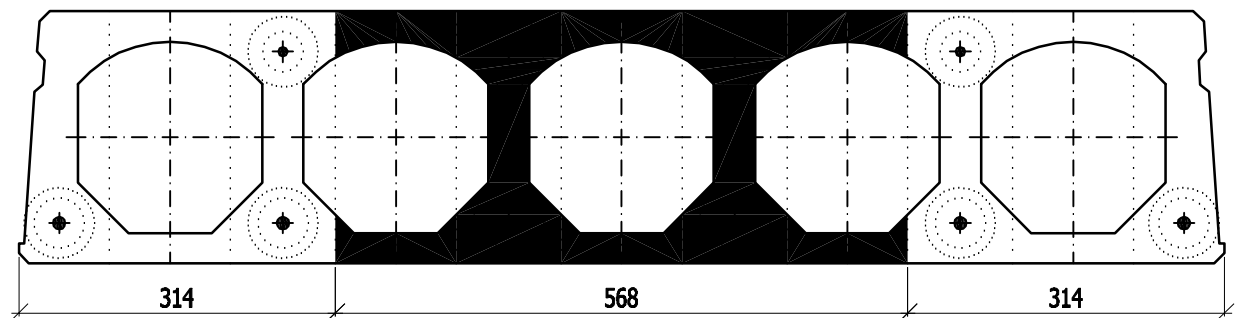
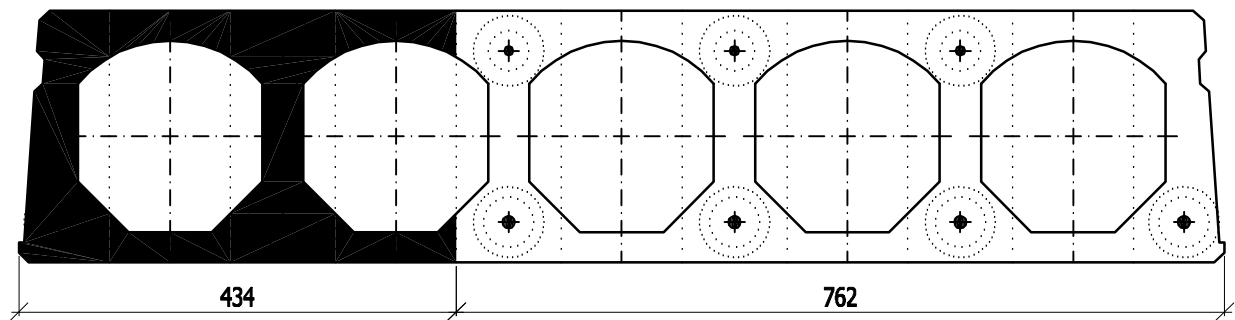
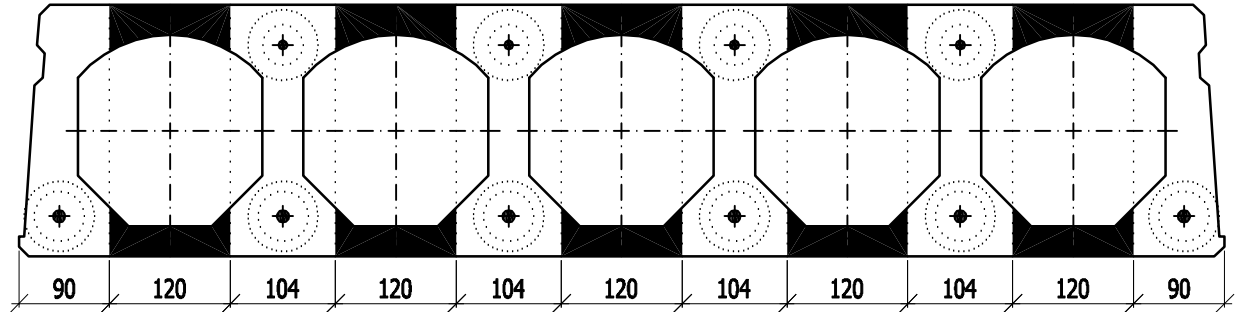

# HCE265 - 0/8X

M 1:7,5

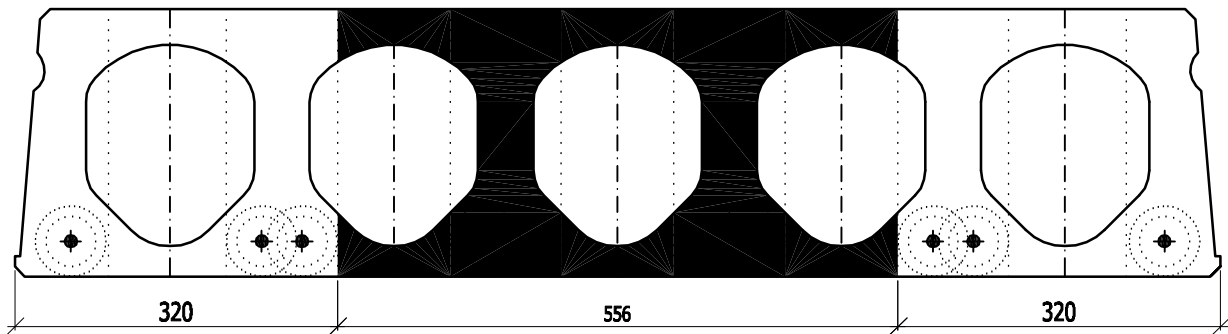
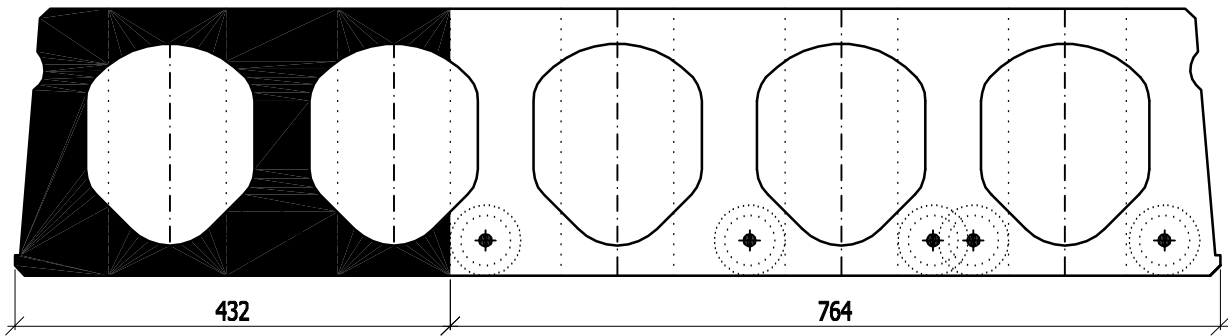
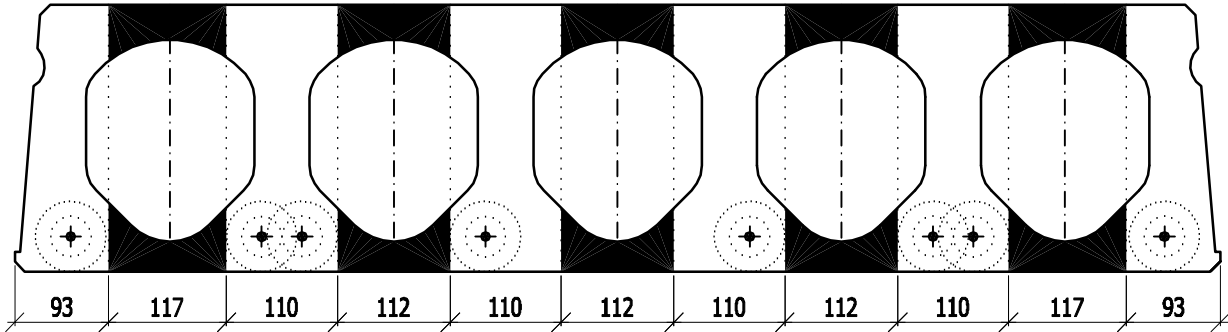

# HCE265 - 0/6

M 1:7,5

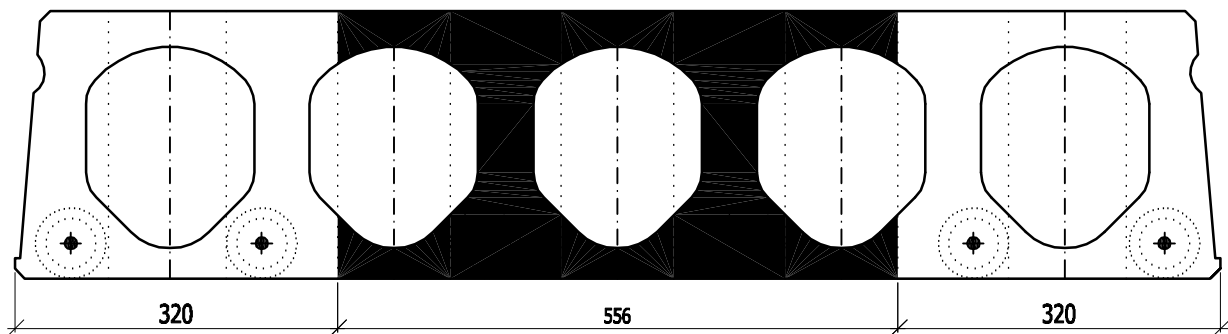
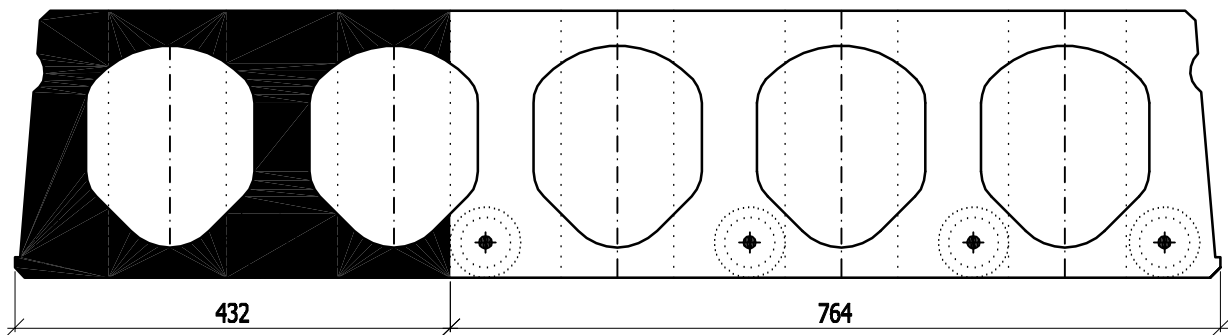
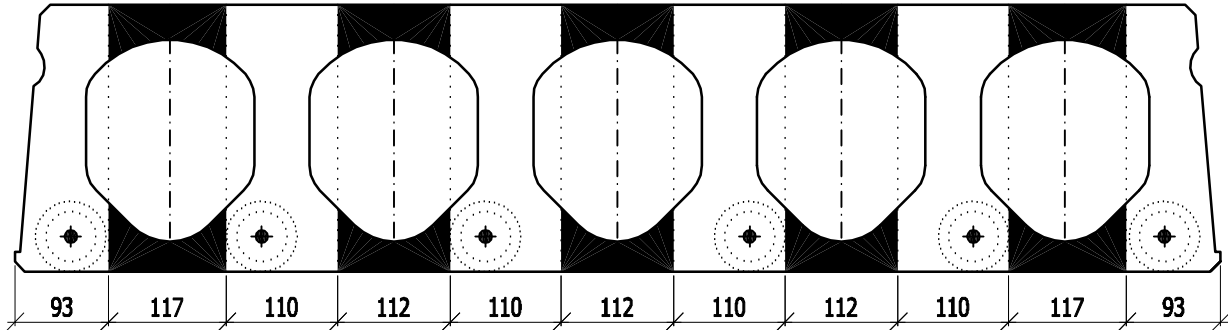

# HCE265 - 0/8

M 1:7,5

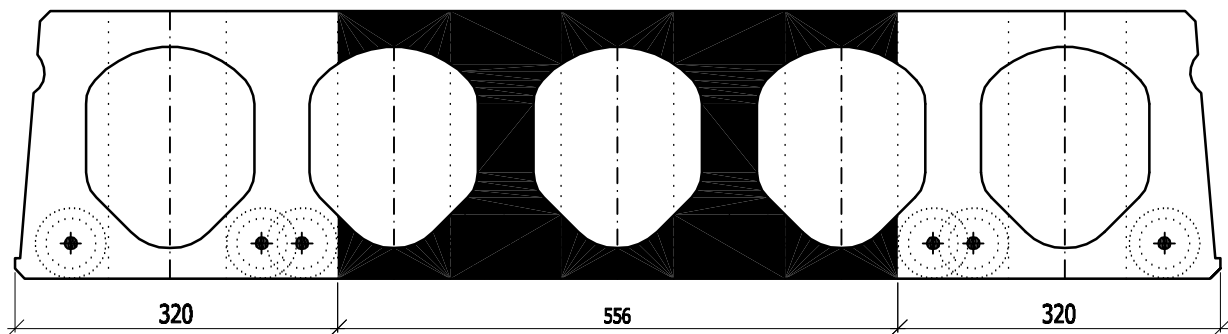
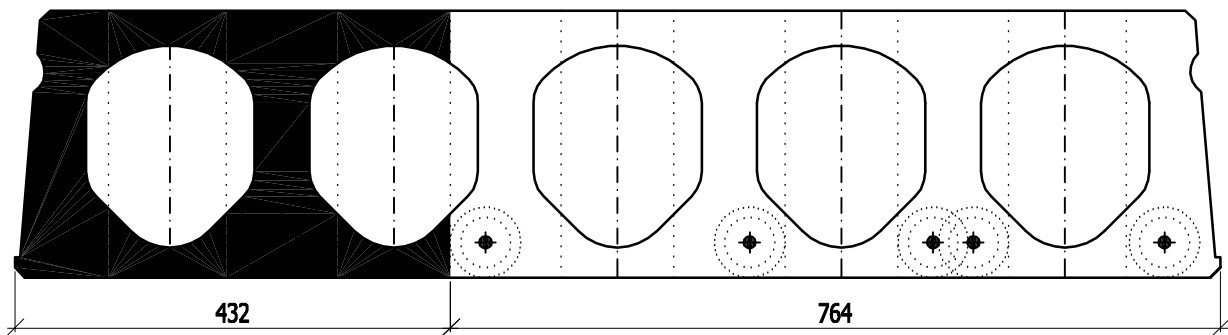
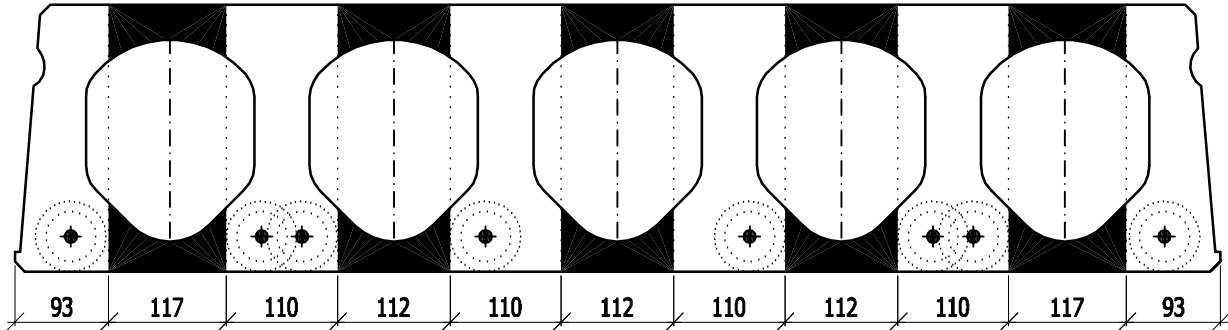

# HCE265 - 0/10

M 1:7,5

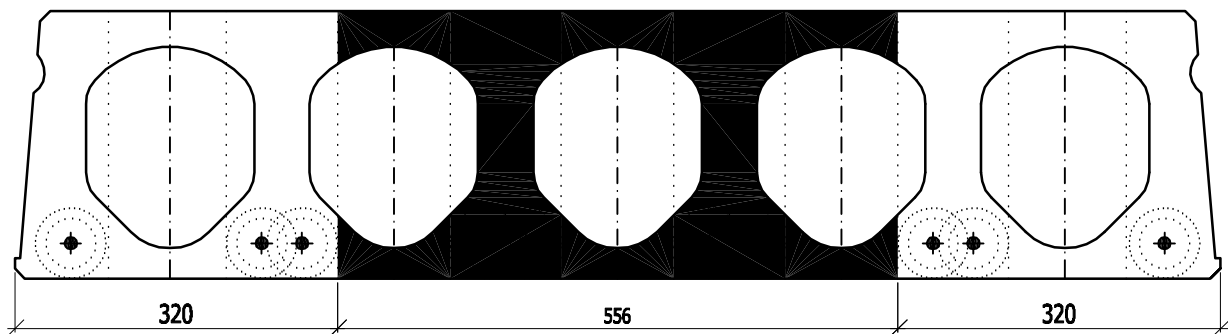
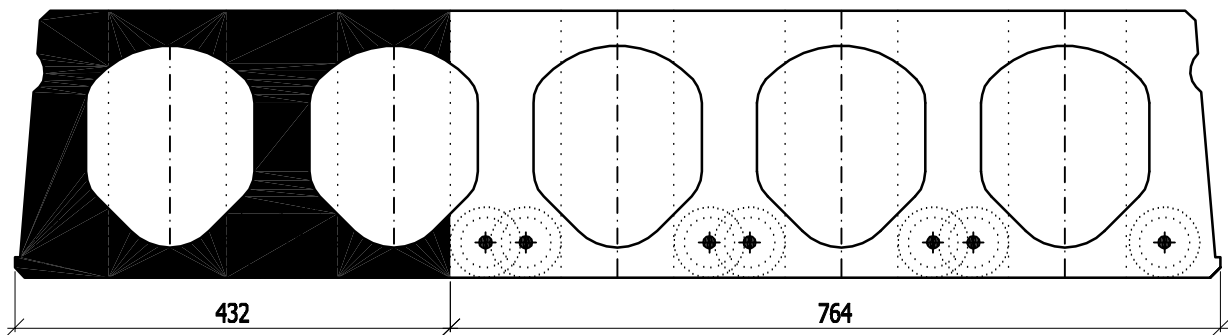
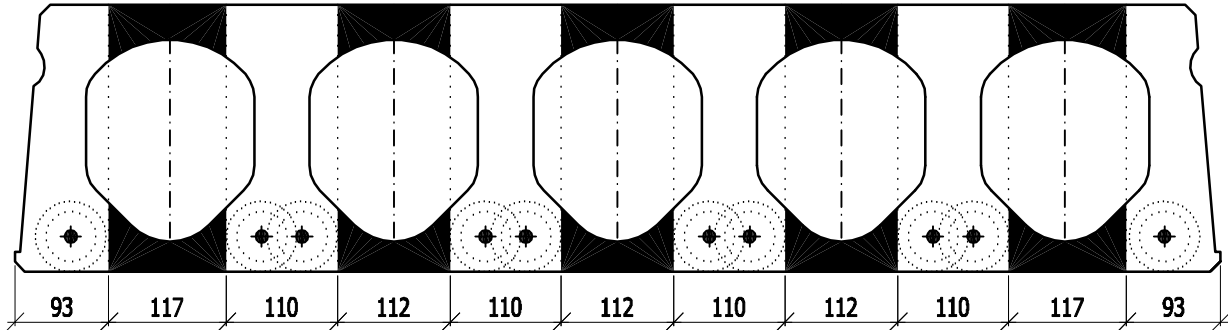

# HCE265 - 4X/6

M 1:7,5

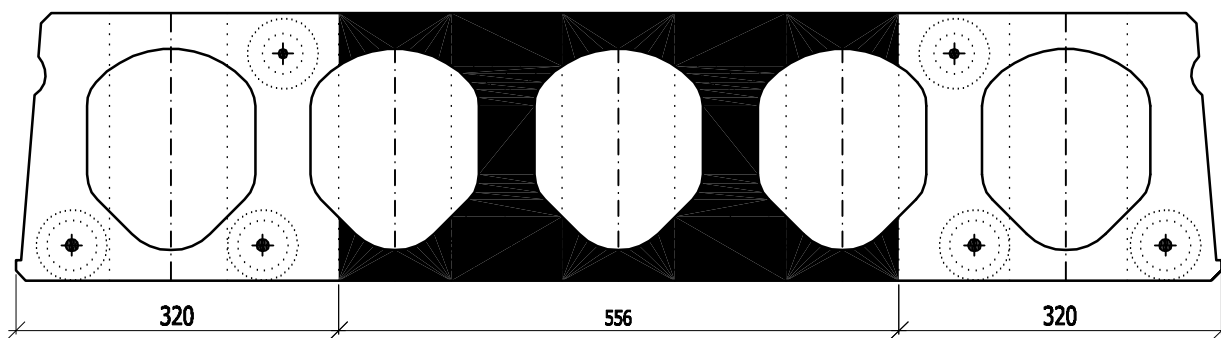
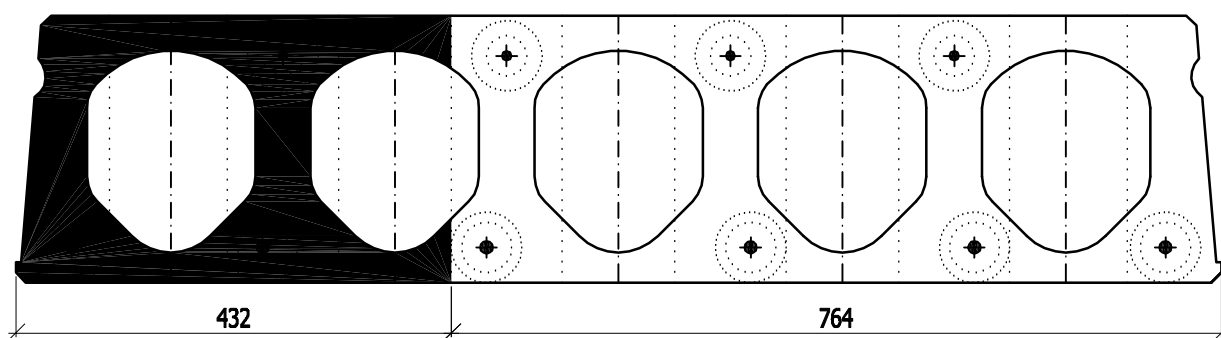
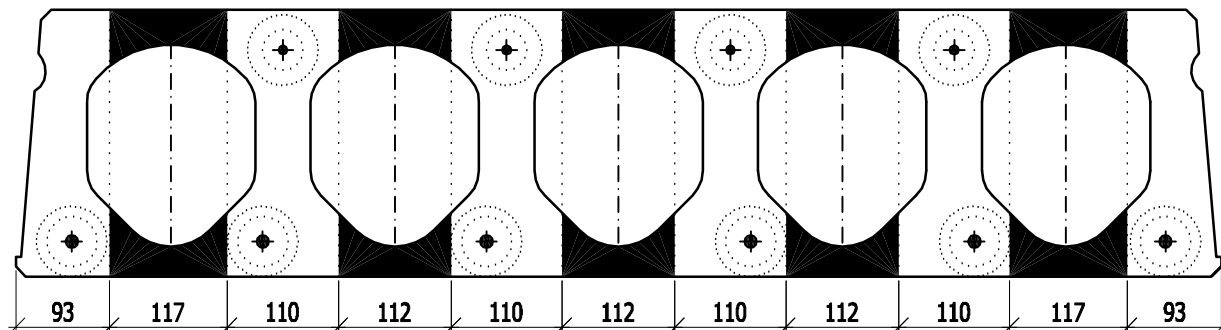

# HCE320 - 0/7

M 1:7,5

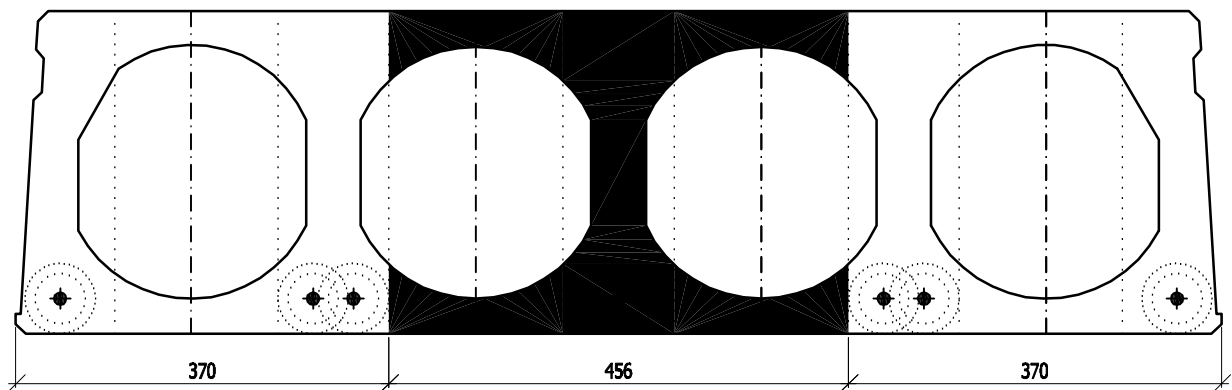
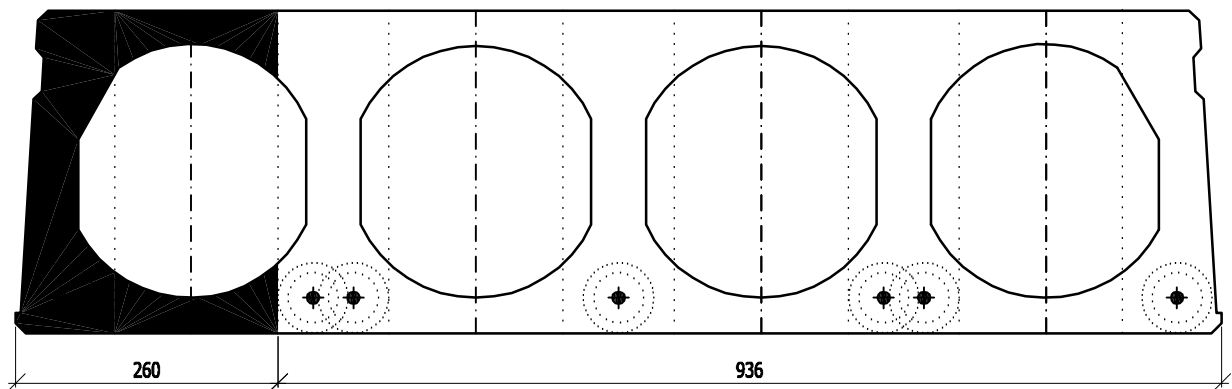
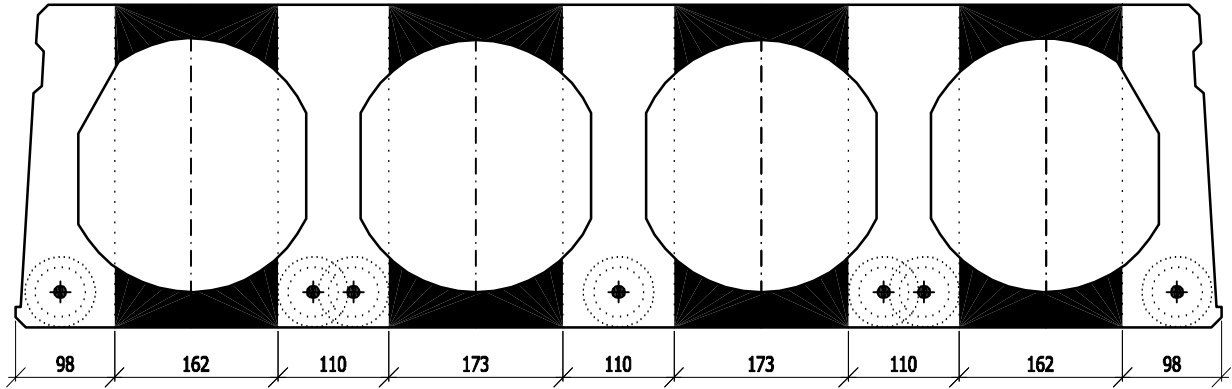

# HCE320 - 0/9

M 1:7,5

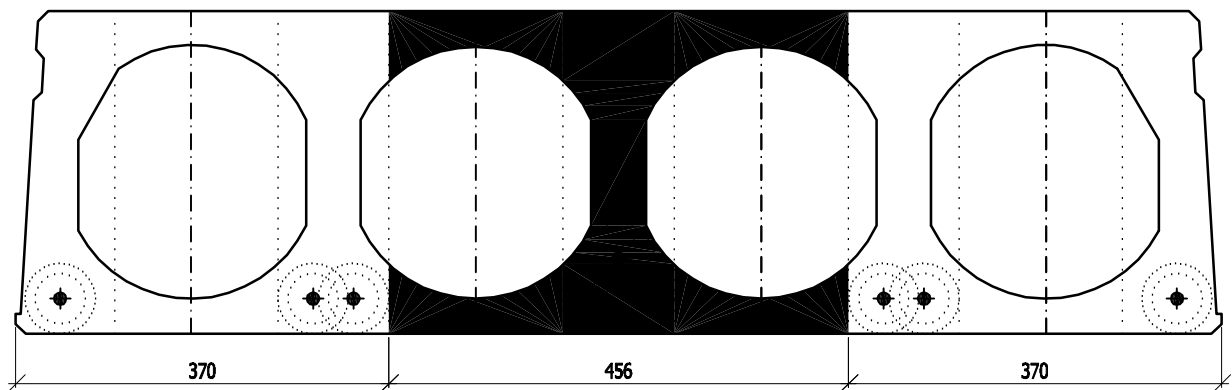
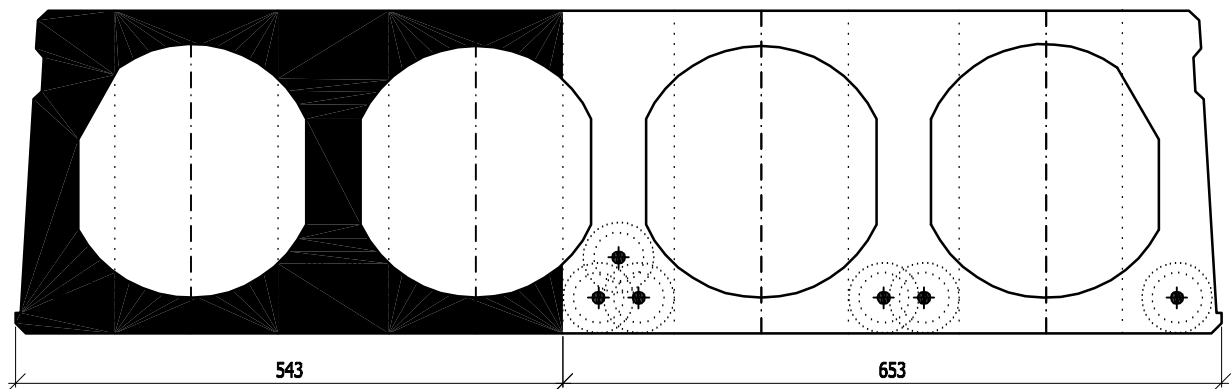
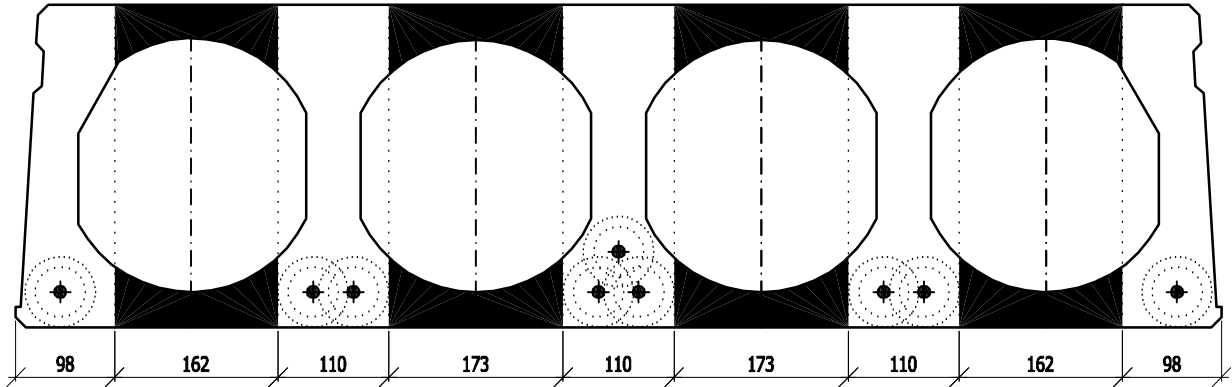

# HCE320 - 0/11

M 1:7,5

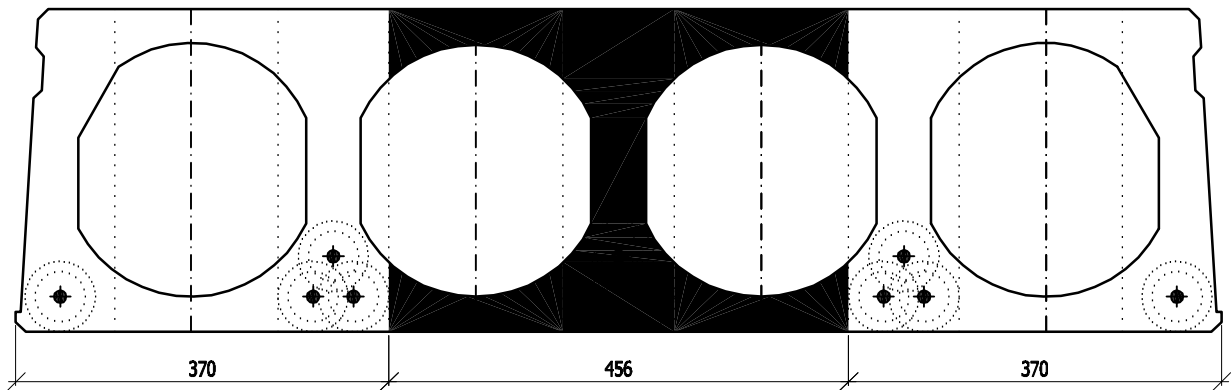
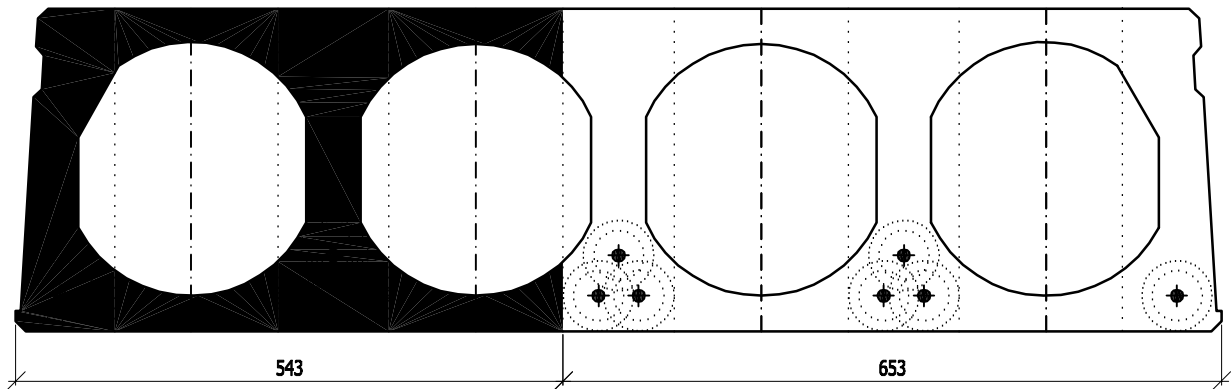
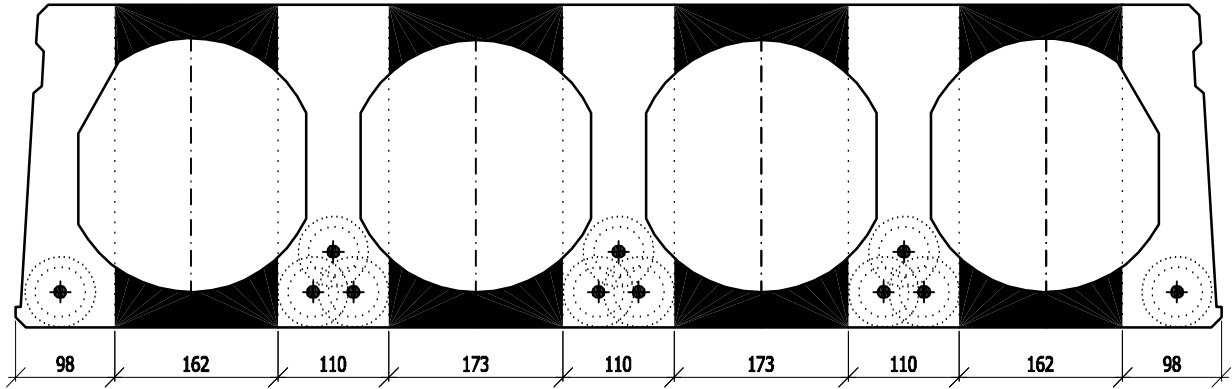

# HCE320 - 0/13

M 1:7,5

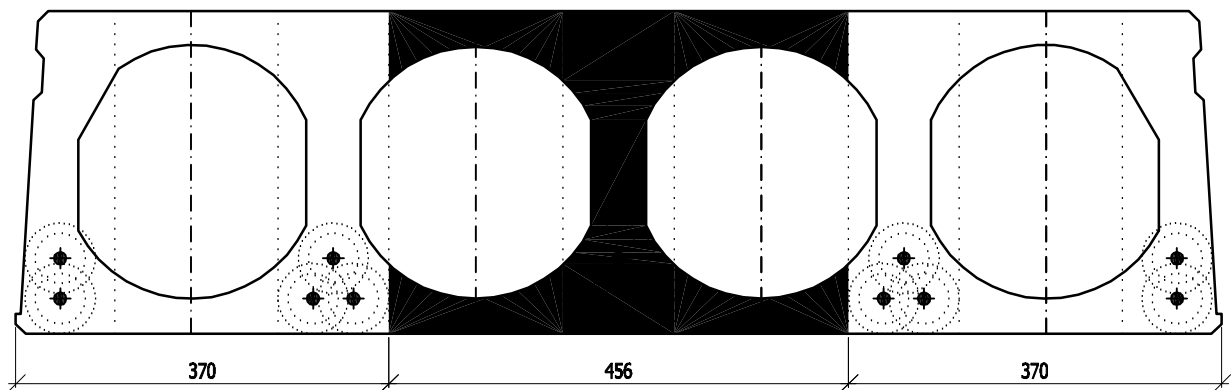
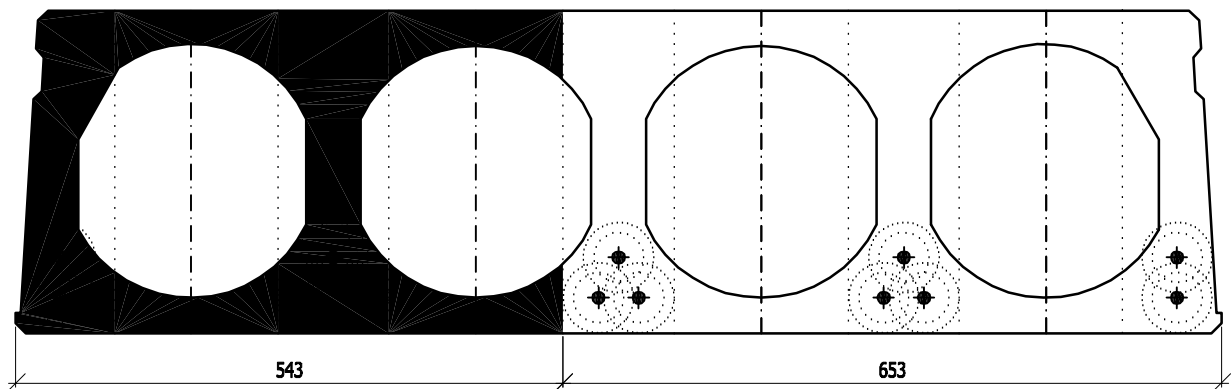
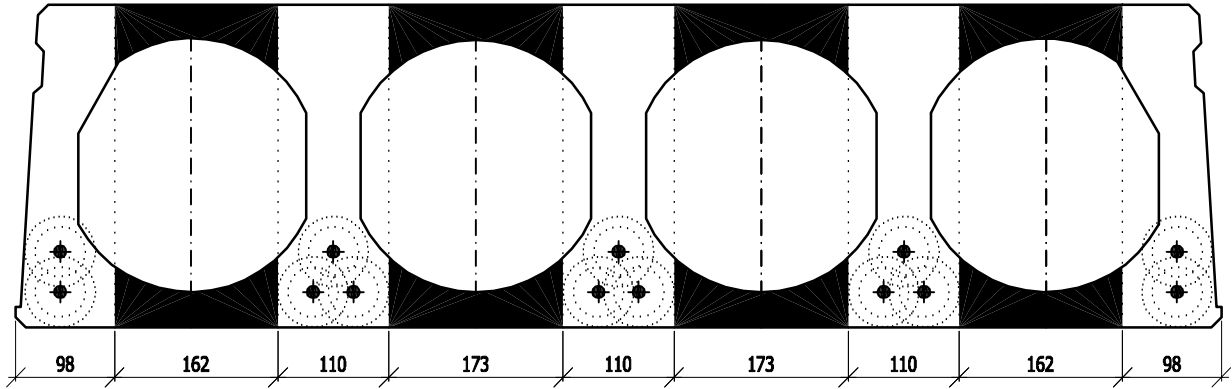

# HCE320 - 3X/13

M 1:7,5

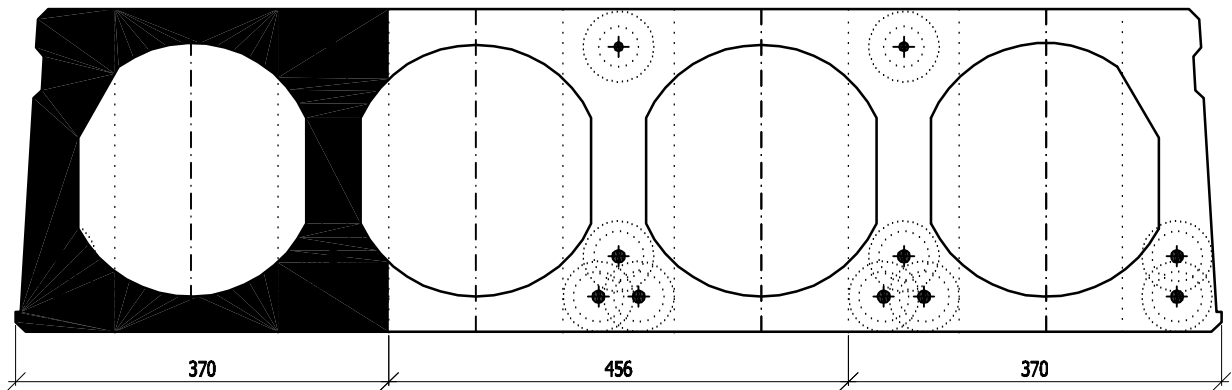
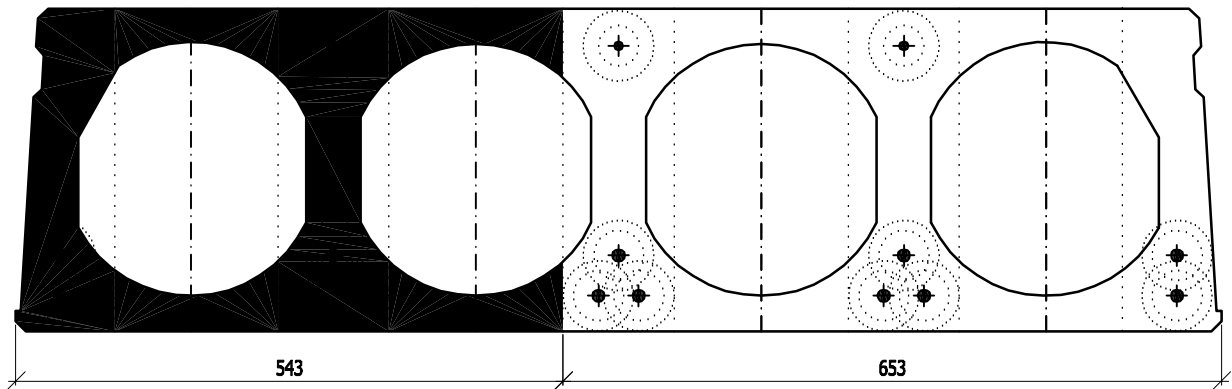
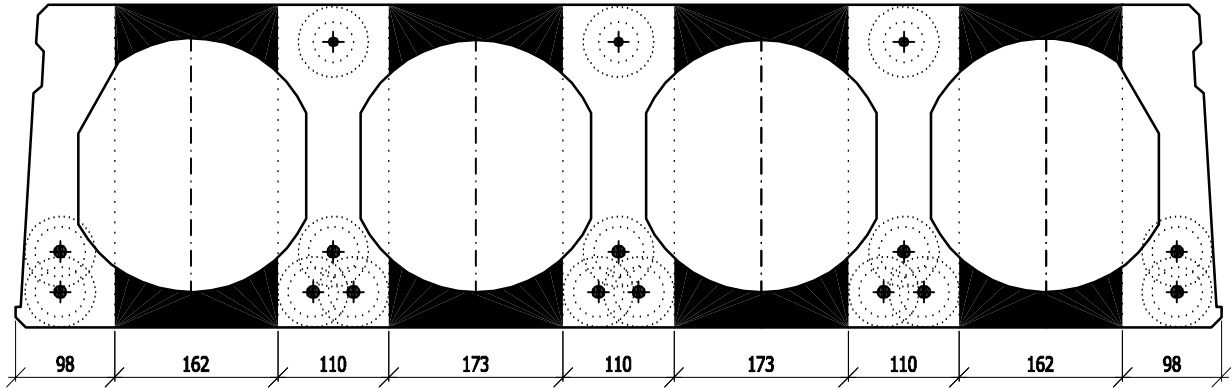

# HCE400 - 0/7

M 1:7,5

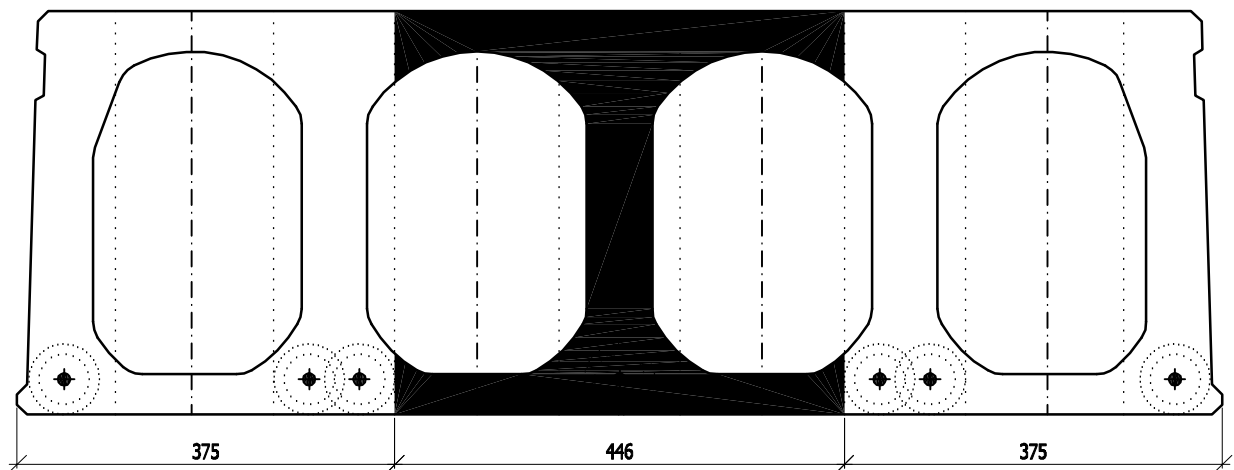
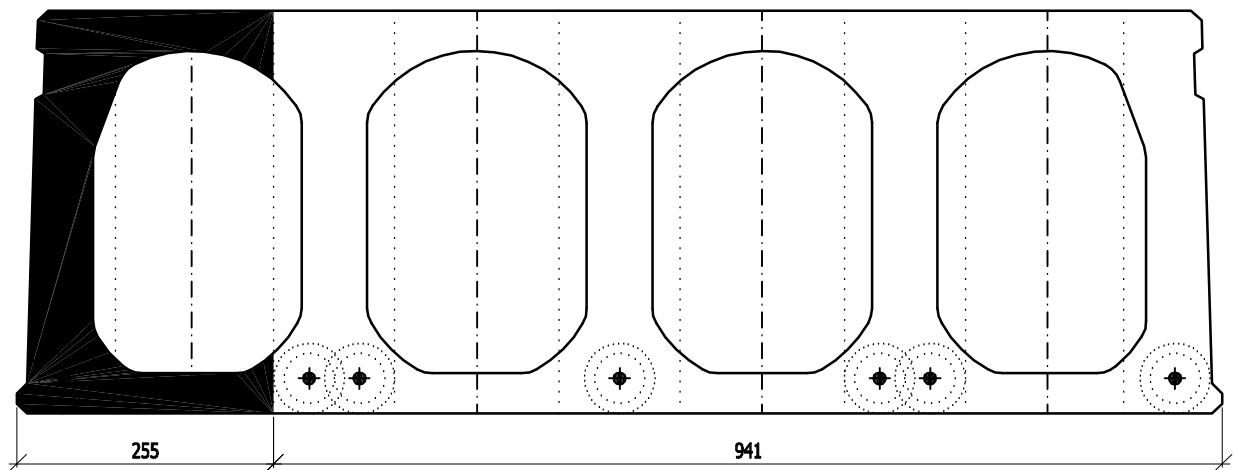
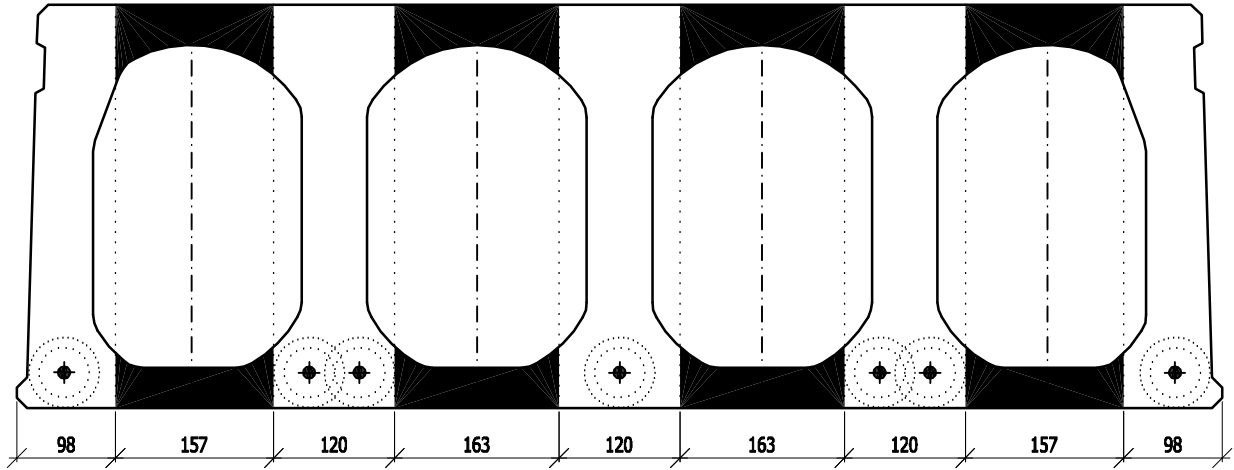

# HCE400 - 0/9

M 1:7,5

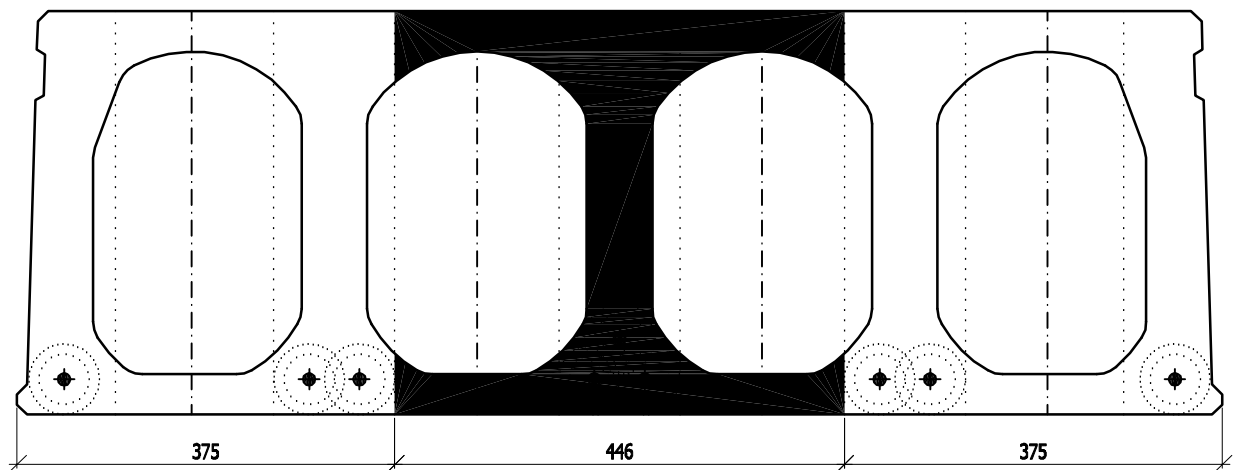
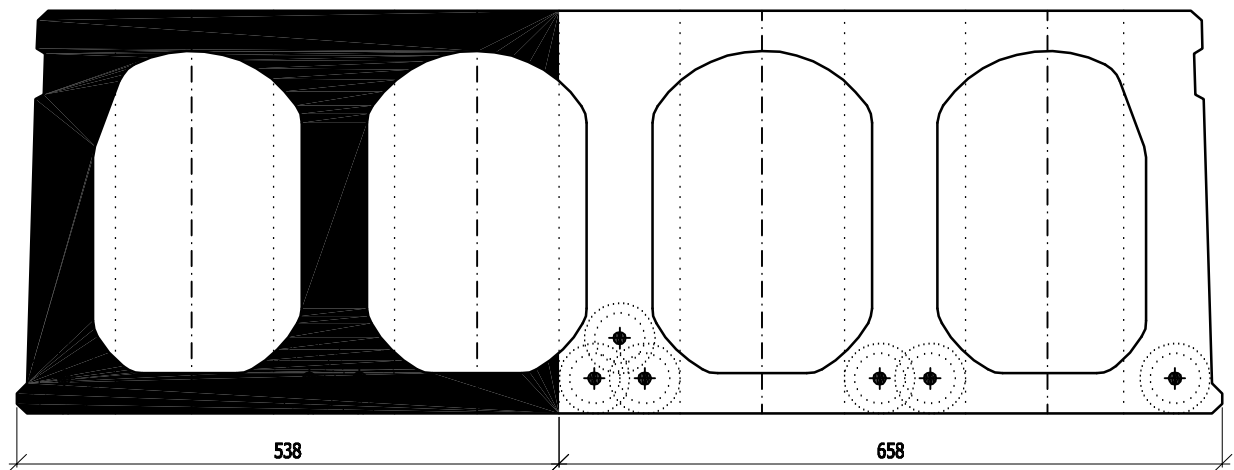
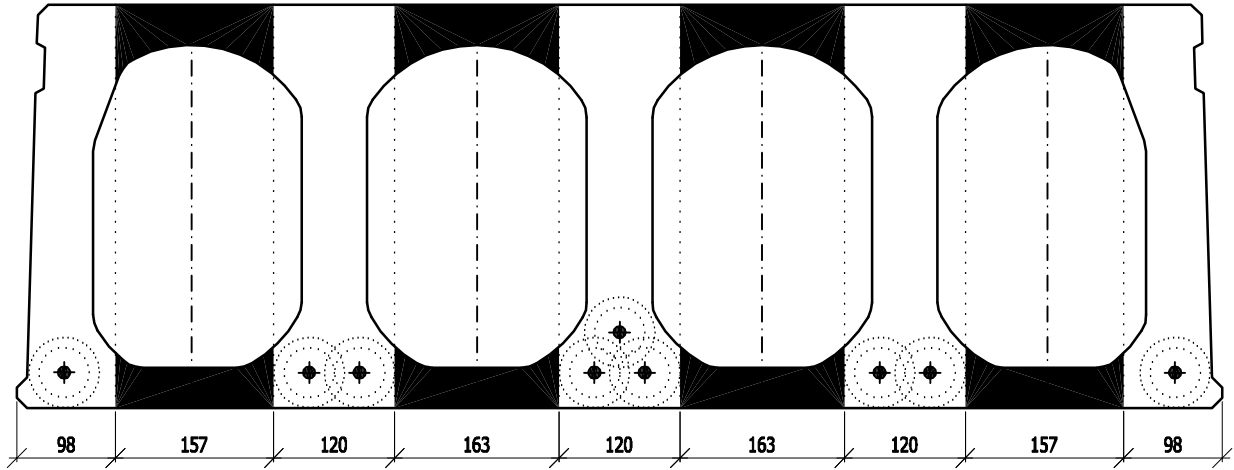

# HCE400 - 0/11

M 1:7,5

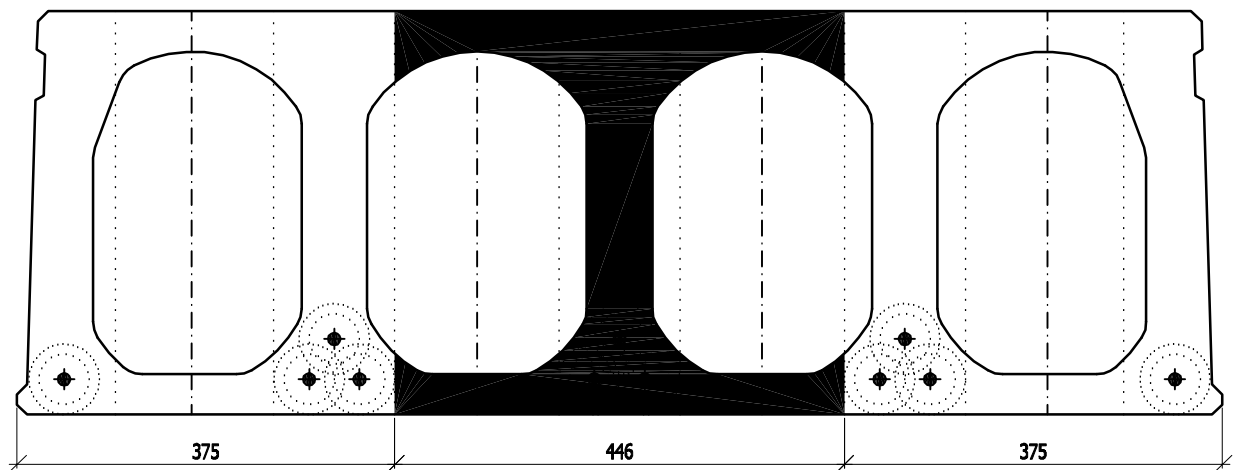
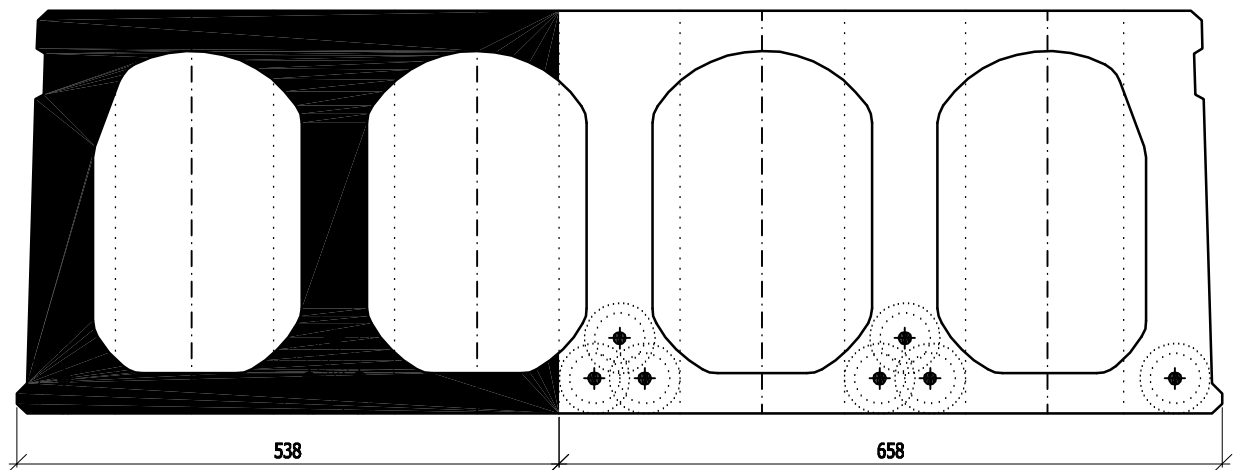
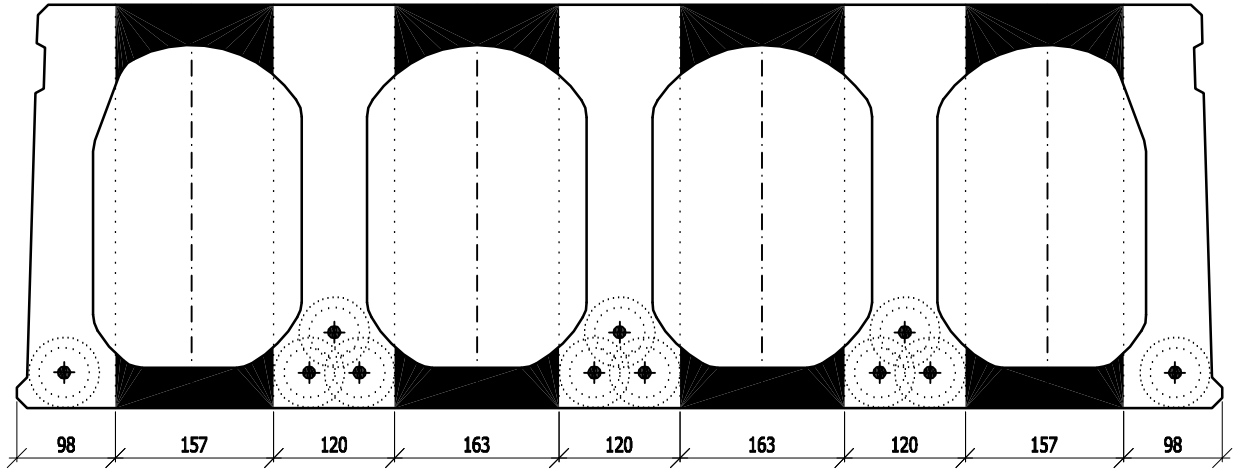

# HCE400 - 0/13

M 1:7,5

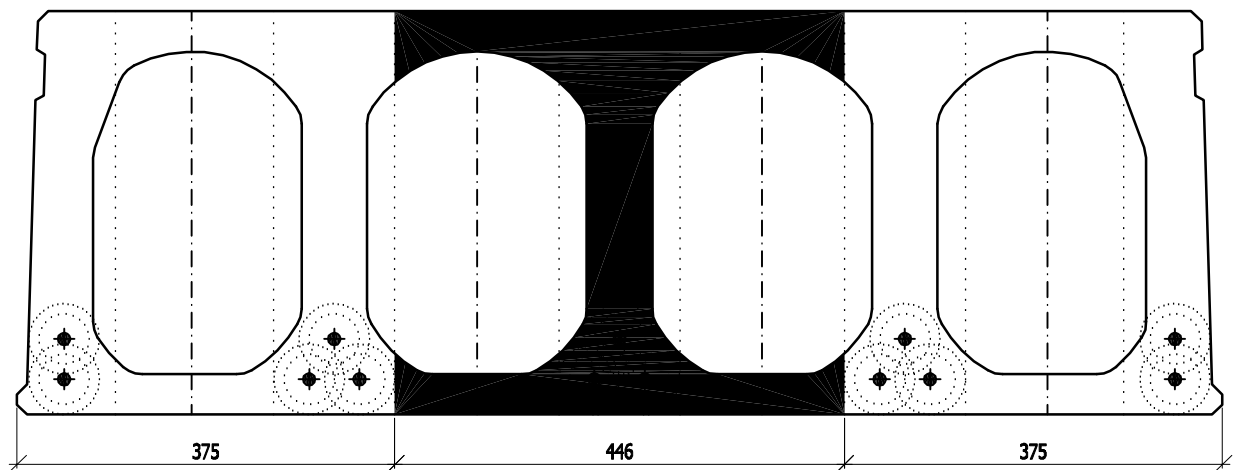
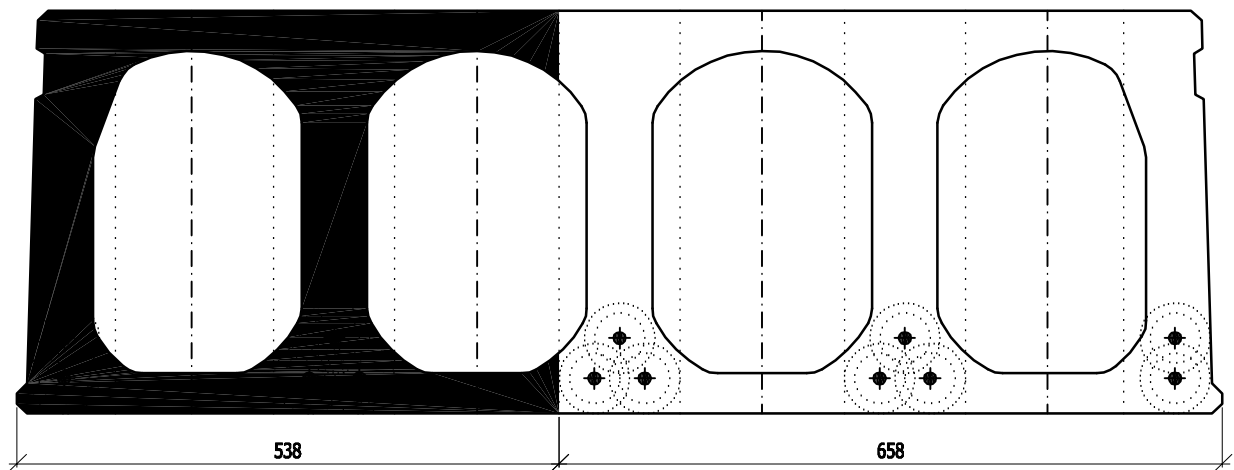
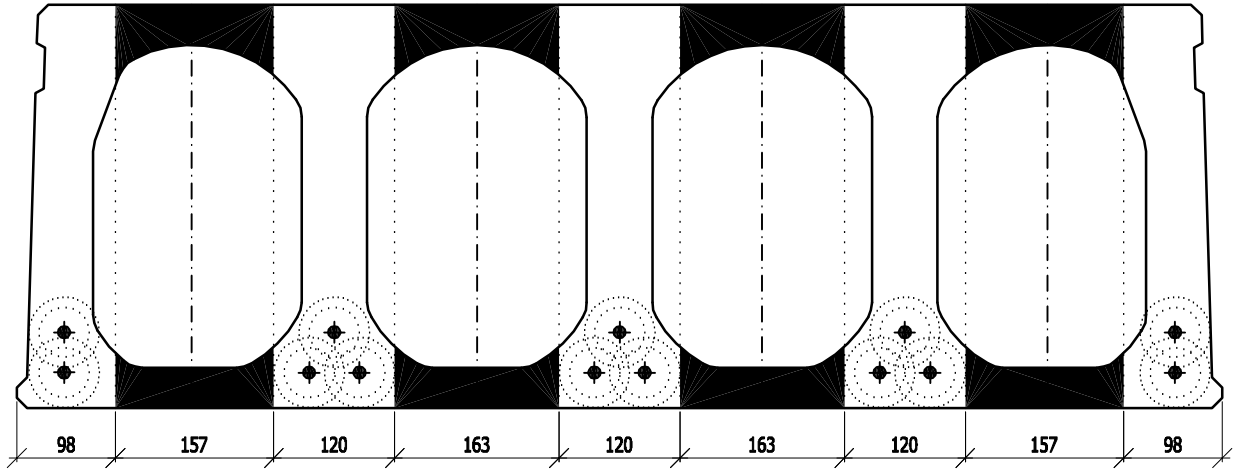

# HCE400 - 3X/13

M 1:7,5

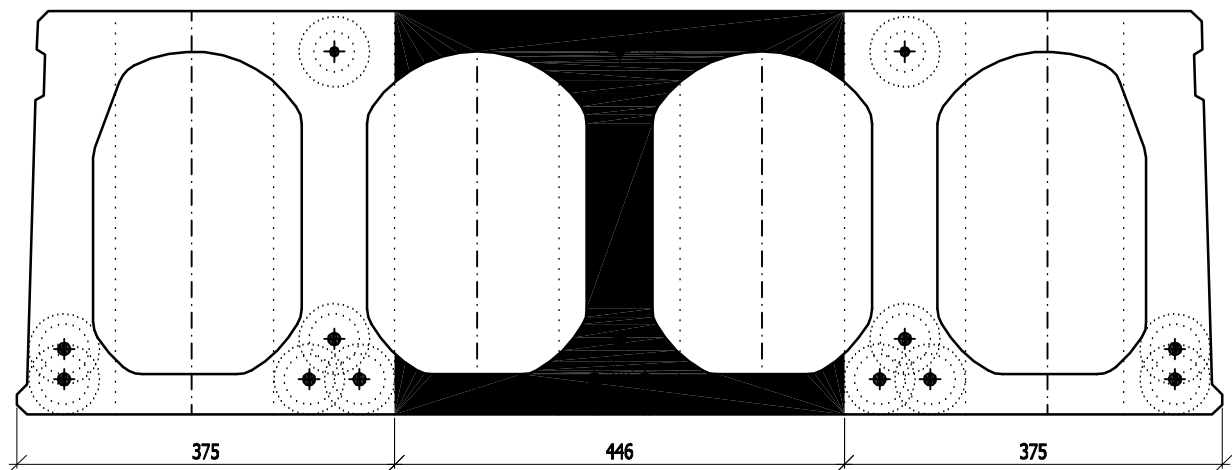
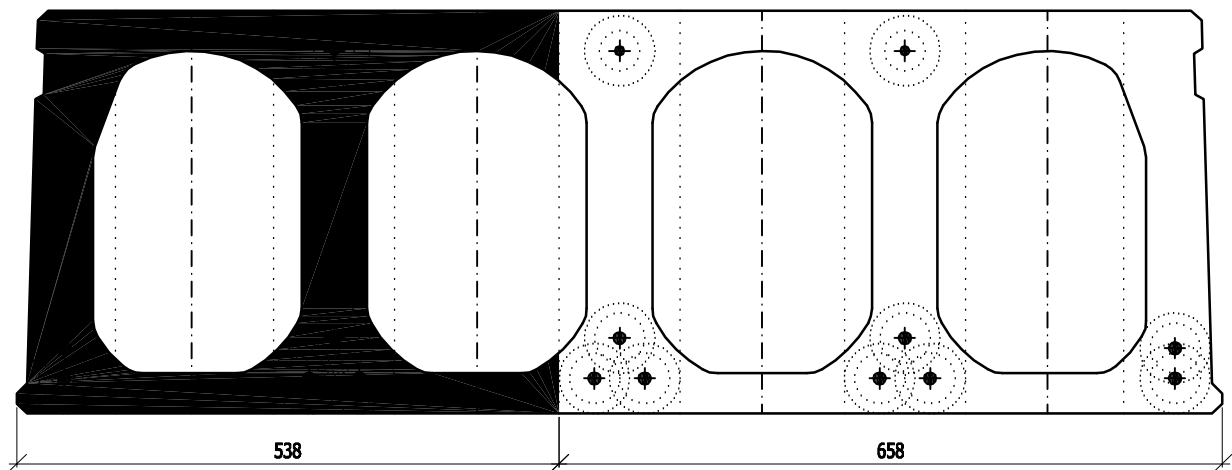
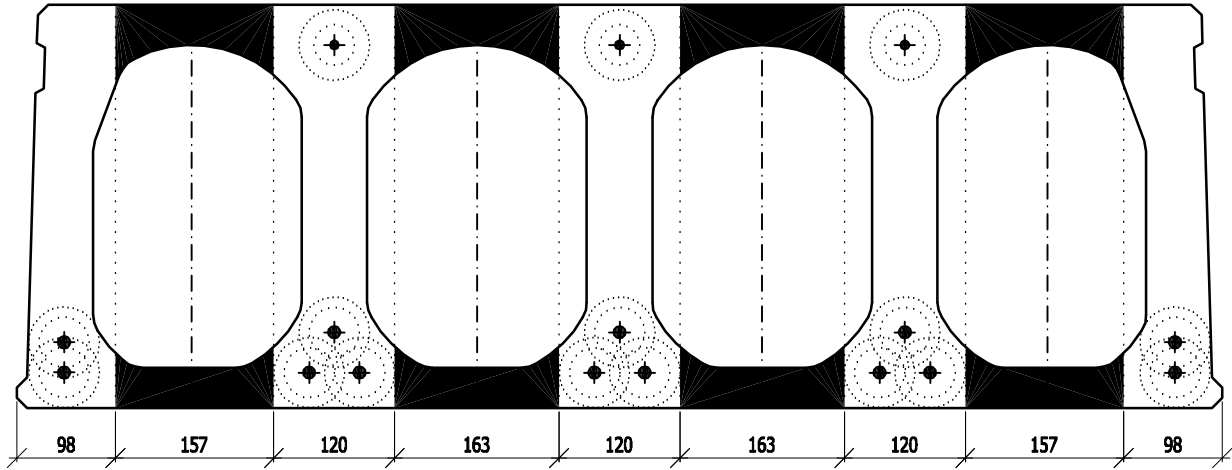

# HCE500-0/9

M 1:7,5

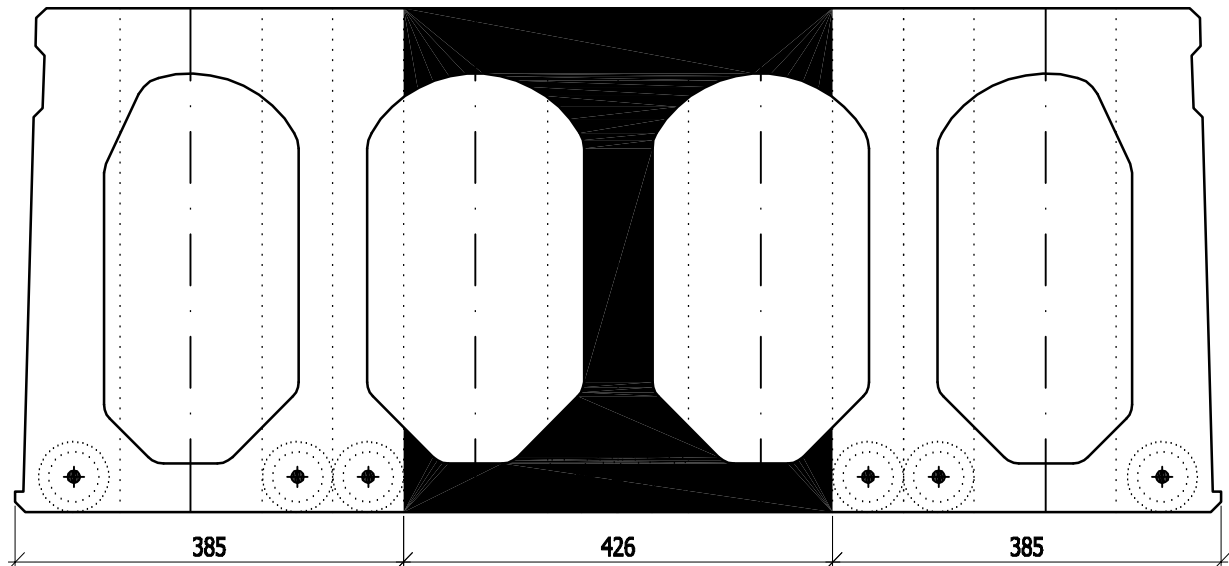
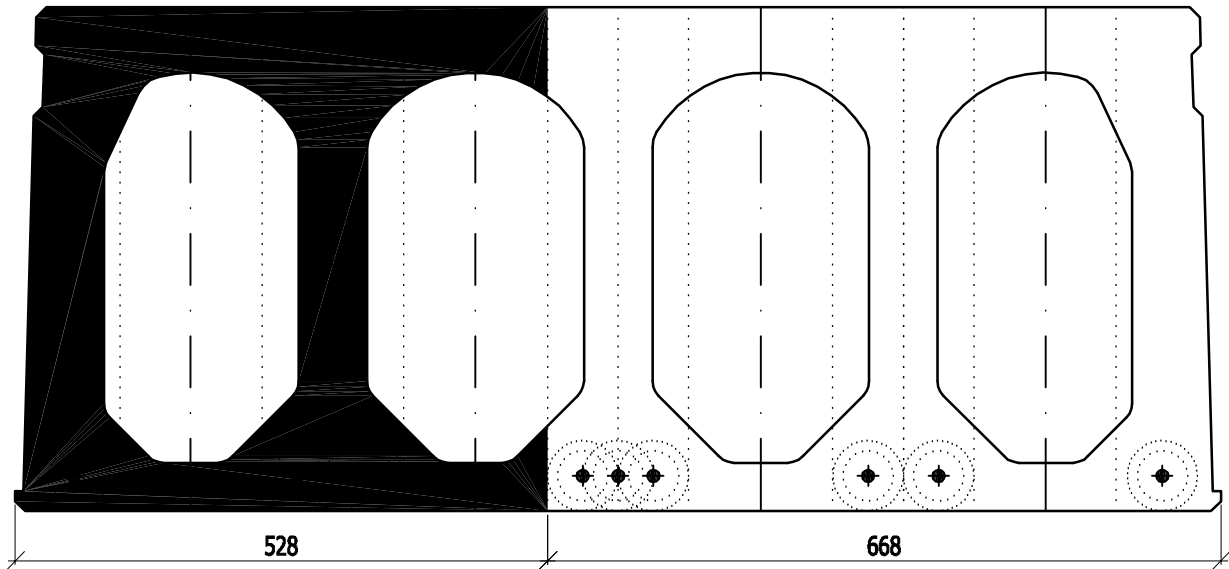
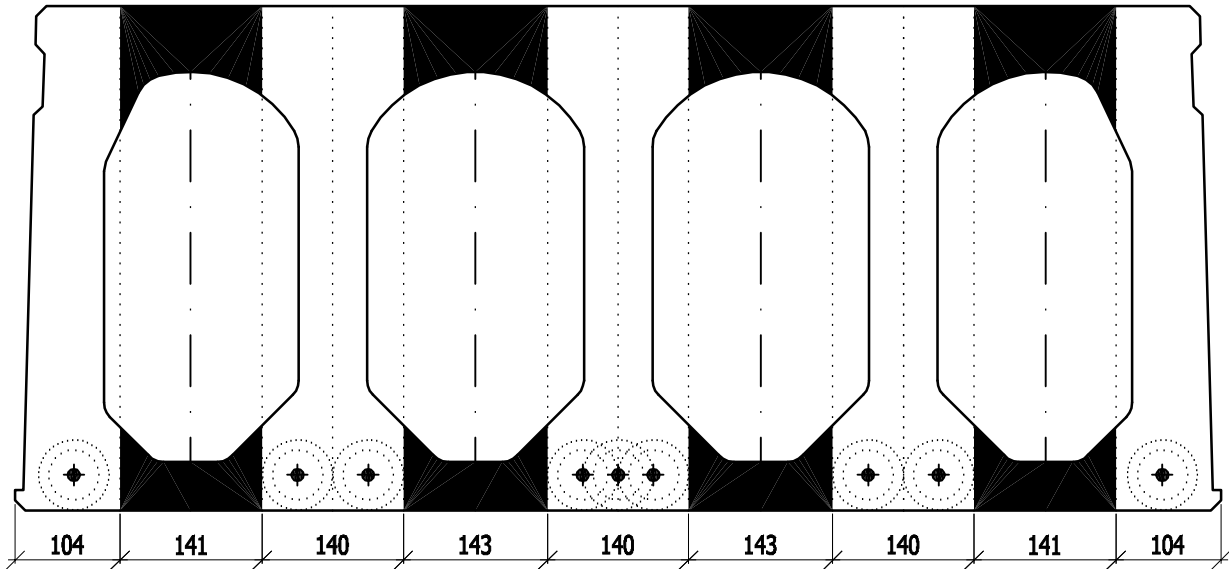

# HCE500-0/11

M 1:7,5

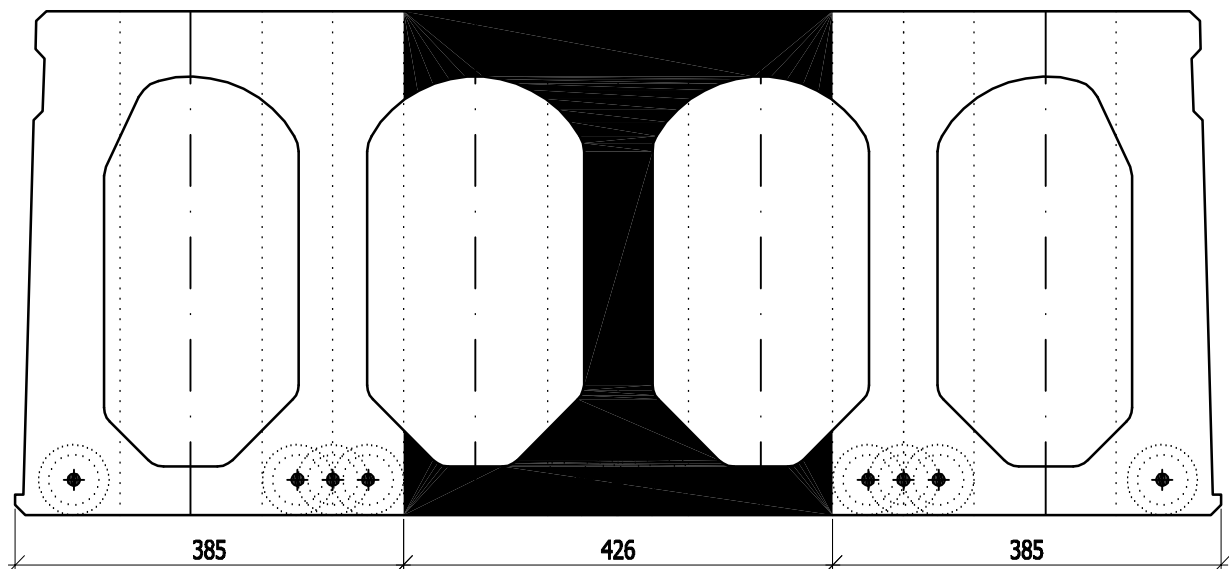
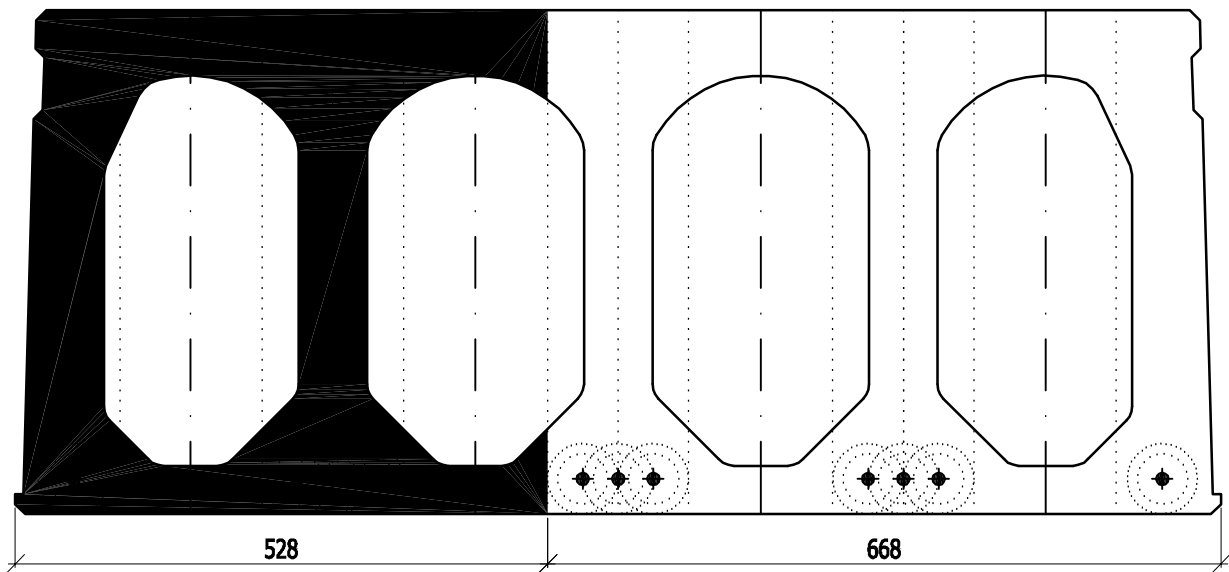
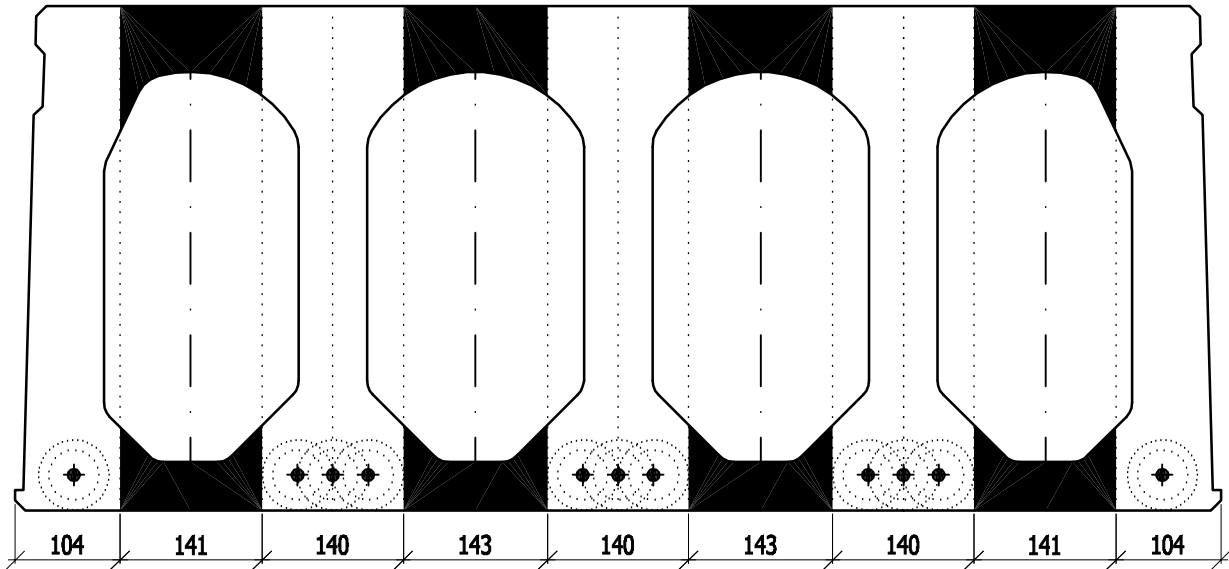

# HCE500-3X/14

M 1:7,5

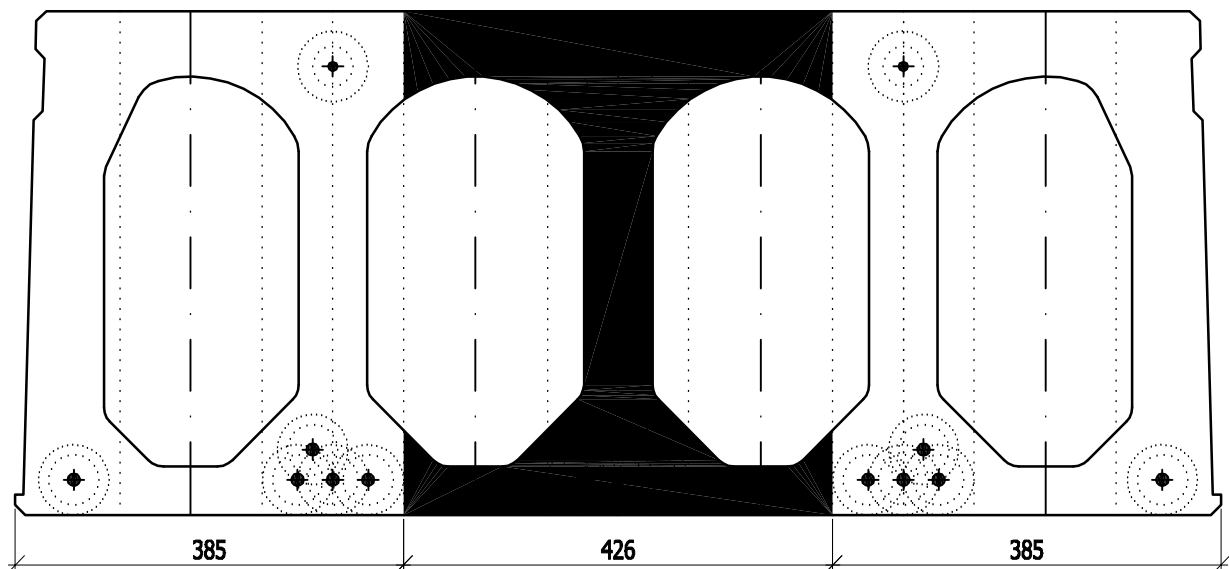
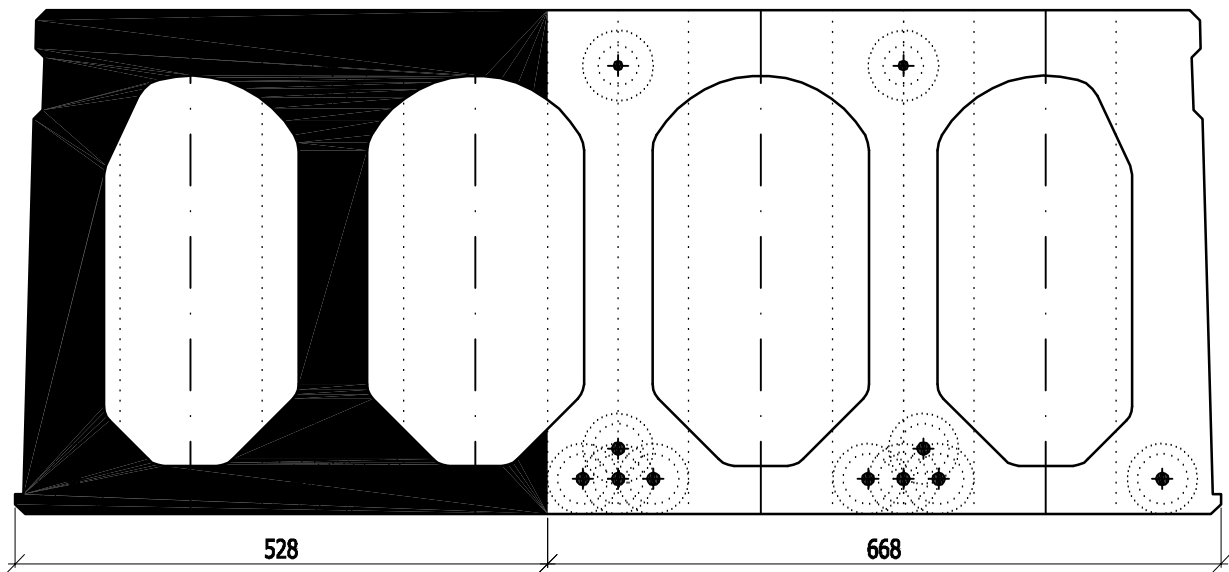
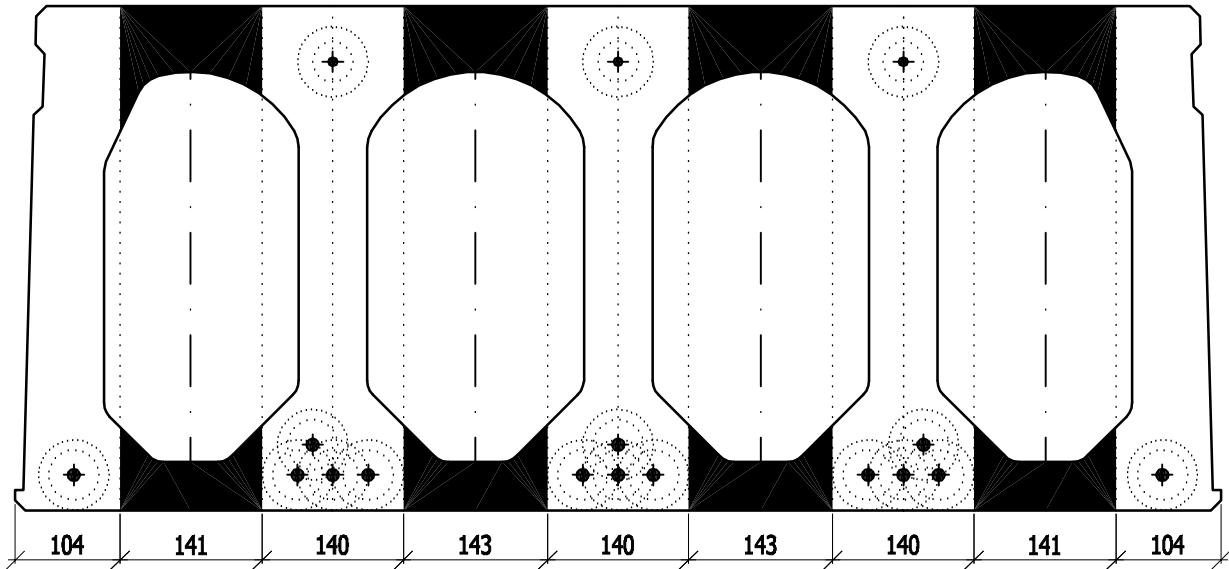

# HCE500-3X/16

M 1:7,5

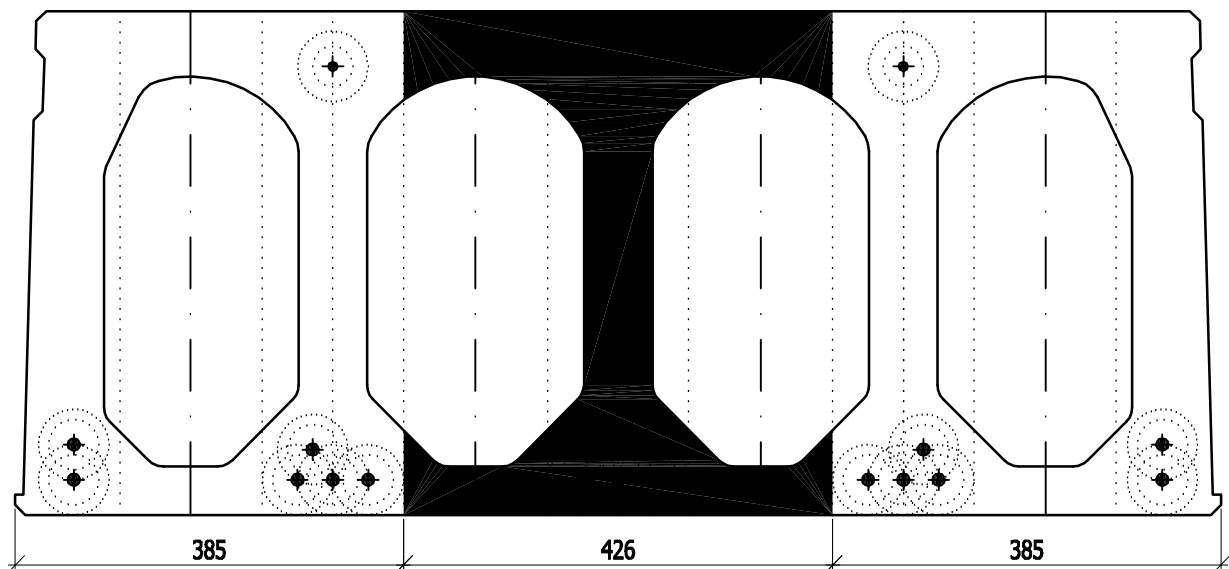
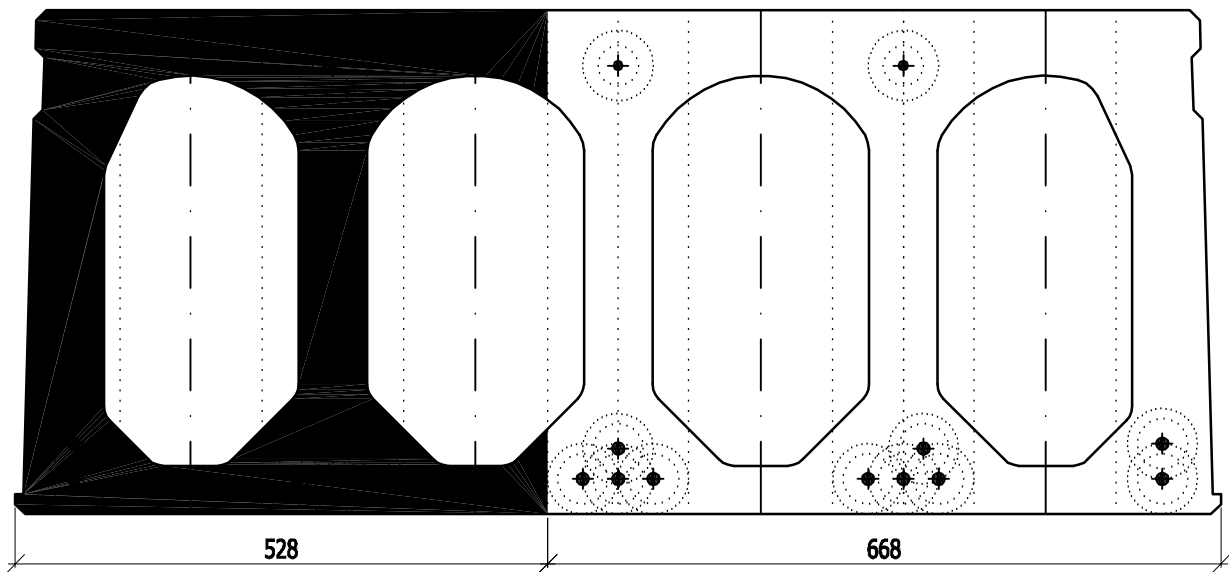
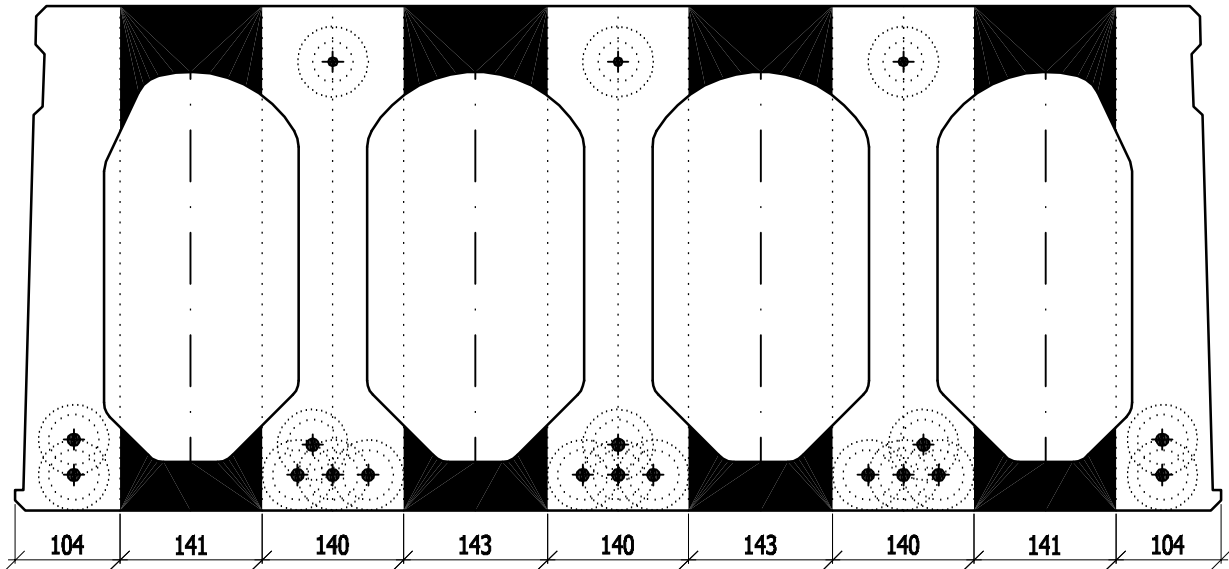

# HCE500-3X/18

M 1:7,5

